

Vision-RTK 2

Fixposition Positioning Sensor

INTEGRATION MANUAL

VERSION 2.2.8



Abstract: This document explains how to integrate the Vision-RTK 2 positioning sensor into a host system and provides comprehensive details on how to configure it to obtain the maximum positioning accuracy.

Document information

Title	Fixposition Vision-RTK 2
Document type	Integration manual
Version number	2.2.8
Published Date	April 22, 2024
Disclosure restriction	Public
Product status	Production

Legal notice: Fixposition or third parties may hold intellectual property rights in the products, names, logos and designs included in this document. Copying, reproduction, modification or disclosure to third parties of this document or any part thereof is only permitted with the express written permission of Fixposition.

The information contained herein is provided "as is" and Fixposition assumes no liability for its use. No warranty, either express or implied, is given, including but not limited to, with respect to the accuracy, correctness, reliability and fitness for a particular purpose of the information. This document may be revised by Fixposition at any time without notice. For the most recent documents, visit <https://docs.fixposition.com/fd/>.

Copyright © 2024, Fixposition AG.

Glossary

ASCII	American Standard Code for Information Interchange
APC	Antenna Phase Center
ARP	Antenna Reference Point
CAN	Controlled Area Network
DHCP	Dynamic Host Configuration Protocol
ECEF	Earth-Centered Earth-Fixed
ENU	East-North-Up
GLONASS	Global Navigation Satellite System (Russian)
GNSS	Global Navigation Satellite System
GPS	Global Positioning System
DOP	Dilution of Precision
FP	Fixposition
IMU	Inertial Measurement Unit
IP	Internet Protocol
LLH	Latitude Longitude Height
NMEA	National Marine Electronics Association
NTRIP	Networked Transport of RTCM via Internet Protocol
OBD-2	On-board Diagnostic 2
ROS	Robot Operating System
RTK	Real Time Kinematics
RTKLIB	Real Time Kinematics Library
RTCM	Radio Technical Commission for Maritime Services
SMA	SubMiniature version A
TCP	Transmission Control Protocol
UART	Universal Asynchronous Receiver-Transmitter
UAV	Unmanned Aerial Vehicle
USB	Universal Serial Bus
UTC	Universal Time Coordinate
VRS	Virtual Reference Station
VRTK2	Vision-RTK 2
WGS-84	World Geodetic System 1984

Contents

Document information	ii
Glossary	iii
1. Vision-RTK 2 Notices	1
1.1. European Union	1
1.2. FCC	2
1.3. Japan	2
1.4. Environmental certifications	3
2. System description	4
2.1. Overview	4
2.2. High-precision sensor fusion	5
2.3. Supported dynamics models	5
3. Technical Information	6
3.1. System indicators	6
3.2. Physical connectors	6
3.2.1. Connectors overview	6
3.2.2. Ethernet	7
3.2.3. I/O connector	7
3.2.4. AUX connector	8
3.2.5. Power connector	8
3.2.6. GNSS connector	8
3.2.7. Wi-Fi connector	8
3.2.8. USB (Type-C)	8
3.2.9. Sensor frame	9
3.2.10. Fixposition logo position	10
3.2.11. Enclosure measurement	11
4. Installation Guidelines	12
4.1. Sensor setup requirements	12
4.1.1. Guidelines for antenna selection	14
4.1.2. Powered by Vision-RTK 2	14
4.1.3. Powered by external power supply	14
4.2. Other considerations	15
4.3. Maintenance procedure	16
5. Sensor Configuration	17
5.1. Web interface overview	17
5.2. Network configuration	19
5.2.1. Network specifications	20
5.2.2. Default route	21
5.2.3. Network data ports	22
5.2.4. Outbound connections	22
5.2.5. USB recovery network	23

5.2.6. Wi-Fi access point	24
5.2.7. Static IP	25
5.3. Time synchronization	26
5.3.1. Network Time Protocol (NTP)	26
5.3.2. Precise Time Synchronization (PTP)	27
5.3.3. Pulse Per Second (PPS)	28
5.4. Input/output system overview	29
5.4.1. UART port configuration	30
5.4.2. CAN streaming port configuration	30
5.4.3. Differences between CANSTR and CAN Interface	32
5.4.4. Output generator	33
5.4.5. Output messages configuration	34
5.4.6. Wheelspeed input options	38
5.5. Correction service configuration	39
5.5.1. Supported RTCM3 messages	42
5.5.2. RTKLIB/str2str	42
5.6. Camera configuration	44
5.6.1. Camera streaming	45
5.7. Wheelspeed sensor configuration	47
5.7.1. Fixposition CAN wheelspeed sensor	49
5.7.2. Verifying Fixposition CAN message configuration	50
5.7.3. Fixposition I/O wheelspeed sensor	51
5.8. Sensor fusion configuration	52
5.9. Log sensor data	53
5.10. IMU calibration	54
5.11. ROS driver installation	56
5.12. Point of interest configuration	57
5.13. Web interface indicators	59
5.14. Web interface tools	62
6. Status Dashboard	65
6.1. GNSS solution types	65
6.2. GNSS status dashboard	66
6.3. Input/output dashboard	69
A. Software Updates	71
B. Coordinate Transformations	72
C. Camera FOV Data and Model	75
D. Antenna Selection	76
E. ROS topic output rate accuracy	77

Vision-RTK 2 Notices

The following notices apply to Vision-RTK 2. Changes or modifications to this equipment, not expressly approved by Fixposition AG., could void the user's authority to operate this equipment.

1.1. European Union

Fixposition AG. hereby declares that Vision-RTK 2 is in compliance with the essential requirements and other relevant provisions of the 2014/30/EU Directive and UN/ECE Regulation 10.

Vision-RTK 2 Wi-Fi

Fixposition AG. declares that Vision-RTK 2 is in compliance with:

1. EU Directive 2014/53/EU.

The full text of the EU Declaration of Conformity may be obtained from the Fixposition website.

Radio Information

- Description of Service: Wi-Fi (802.11b/g/n).
- Operational Frequency: 2400 MHz to 2480 MHz.
- Modulation: OFDM.
- Rated Power: 17.5 dBm e.i.r.p.

The full text of the EU Declaration of Conformity may be obtained from the Fixposition website.

WEEE Notice

If you purchased your Vision-RTK 2 product in Europe, please return it to your dealer or supplier at the end of its life. The objectives of Fixposition's environment policy are, in particular, to preserve, protect and improve the quality of the environment, protect human health, and utilize natural resources prudently and rationally. Sustainable development advocates the reduction of wasteful consumption of natural resources and the prevention of pollution. Waste electrical and electronic equipment (WEEE) is a regulated area. Where waste generation cannot be avoided, it should be reused or recovered for its material or energy. WEEE products may be recognized by their wheeled bin label.



RoHS

The Vision-RTK 2 is in conformity with:

1. Directive 2011/65/EU of the European Parliament and of the Council of 8 June 2011 on restricting the use of certain hazardous substances in electrical and electronic equipment.
2. The Restriction of the Use of Certain Hazardous Substances in Electrical and Electronic Equipment Regulations 2012 (S.I. 2012/3032).

1.2. FCC

This device complies with part 15 of the FCC Rules. Operation is subject to the following two conditions: (1) this device may not cause harmful interference, and (2) this device must accept any interference received, including interference that may cause undesired operation. Vision-RTK 2 has been tested and found to comply with the radiated and conducted emission limits for a Class B digital device. The Class B limits are designed to provide reasonable protection against harmful interference in a residential installation. The equipment listed generates, uses, and can radiate radio frequency energy and, if not installed and used in accordance with the instructions, may cause harmful interference to radio communications. However, there is no guarantee that interference will not occur in a particular installation. If this equipment does cause harmful interference to radio or television reception, which can be determined by turning the equipment off and on, the user is encouraged to try to correct the interference by one or more of the following measures:

- Re-orient or relocate the Vision-RTK 2.
- Increase the separation between the equipment and the Vision-RTK 2.
- Connect the equipment to an outlet on a circuit different from that to which the Vision-RTK 2 is connected.
- Consult the dealer or an experienced radio/TV technician for help.

To maintain compliance with the limits of a Class B digital device, you must use shielded interface cables.

The Vision-RTK 2 has been authorized for use in Mobile applications. At least 20 cm (8 in) of separation between the Vision-RTK 2 and the User must be maintained at all times.

Wi-Fi

The Vision-RTK 2 contains a Wi-Fi radio with the following approvals:

- FCC ID: TFB-1004

1.3. Japan

Wi-Fi

Vision-RTK 2 contains a Wi-Fi radio with the following approvals:



Remarks and observations

The following conditions are applicable:

- Antennas for IEEE 802.11a/b/g/n/ac.
- Listed are 2 Dipoles, 1 PIFA, and 1 Chip antenna with a max antenna peak gain of 2.5 dBi at 2.4 GHz and 4.0 dBi at 5.0 GHz.

1.4. Environmental certifications

IP66

The Vision-RTK 2 is certified as IP66 (i.e., dust and water-resistant). This certification was granted after the sensor had been exposed to the following tests:

- Temperature cycling (IEC60068-2-14 Na): 200 cycles, -30°C to 85°C, hold time of 30 minutes per temperature.
- Salt spray with SO₂ corrosion (IEC60068-2-11 Ka): 48 hours, 35°C, 5% NaCl Sole.

Then, the sensor's enclosure protection level was confirmed against water and dust ingress by being subjected to the following tests:

- Powerful water jets with a 12.5 mm nozzle from any direction.
- Put inside a dust chamber.

System description

2.1. Overview

The Vision-RTK 2 is a high-end sensor fusion solution that provides real-time high-accuracy pose information in all scenarios, including GNSS degraded and denied environments.

The system includes two multi-frequency Real-Time Kinematics (RTK) GNSS receivers for instant heading calculation after initialization, an embedded camera, and an Inertial Motion Unit (IMU) to provide continuous high-accuracy positioning even in extended GNSS outages.

The system can also receive information from additional auxiliary sensors (such as wheel-speed) to increase performance whenever required.

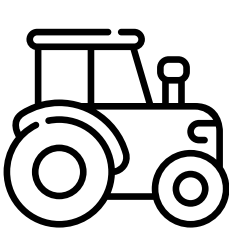

(a) Agriculture

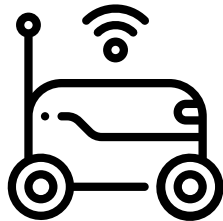

(b) Urban



(c) Lawn mowing

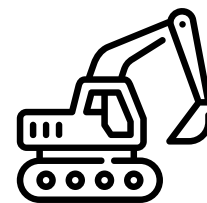

(d) Mining

The Vision-RTK 2 is the ideal solution for applications in robotics, precision agriculture, autonomous driving, infrastructure mapping, outdoor industrial applications, and many others.

2.2. High-precision sensor fusion

Vision-RTK 2 provides accurate and reliable position, velocity, and orientation measurements by fusing visual odometry with several sensor data streams, including in extended GNSS outages.

2.3. Supported dynamics models

Vision-RTK 2 supports several navigation modes to adjust to different platforms' specific dynamics. These modes capture the data streams from the selected vehicle type and tune the sensor fusion algorithm to improve performance based on the platform restrictions. Table 2.1 summarizes the characteristics of each tuning mode.

Mode	Application	v range	ω range
Generic	Default mode that covers most platforms' dynamics.	± 3 m/s	1.5 rad/s
Car	Dynamics similar to that of a passenger car.	± 22 m/s	0.5 rad/s
Lawnmower	Dynamics similar to that of a lawnmower robot.	± 3 m/s	1.0 rad/s
Slow robot	Dynamics similar to that of a slow-moving utility robot.	± 3 m/s	0.5 rad/s

Table 2.1.: Supported sensor fusion modes

$\cdot v$: Velocity

$\cdot \omega$: Angular velocity

Enabling a wheelspeed sensor is recommended for optimal performance. All tuning modes support wheelspeed. Note that the above v and ω values correspond to the expected dynamics for these vehicles. However, even though the sensor does not strictly enforce these ranges, exceeding these values can degrade performance.

Technical Information

3.1. System indicators

The Vision-RTK 2 has three LEDs to indicate the current status of the sensor.

- **Green:** System running
- **Amber:** System activity (intermittent blinking)
- **Red:** Not in use

3.2. Physical connectors

3.2.1. Connectors overview

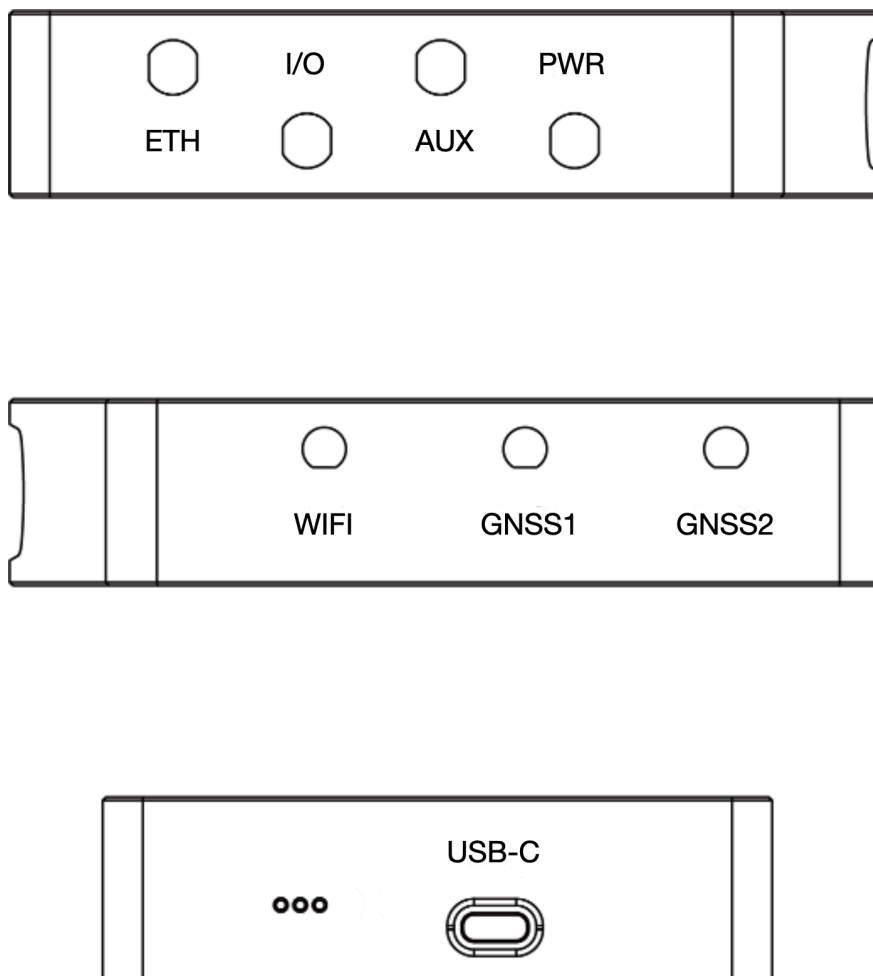

Figure 3.1.: Vision-RTK 2 connectors overview

Note: The Vision-RTK 2 exists in two variants. Variants manufactured before October 2022 were equipped with male connectors on the sensor, and future sensors will contain female connectors.

3.2.2. Ethernet

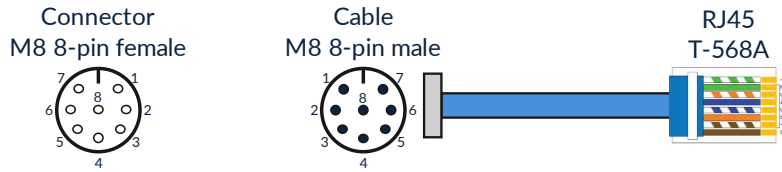

Figure 3.2.: Ethernet connector standard

3.2.3. I/O connector

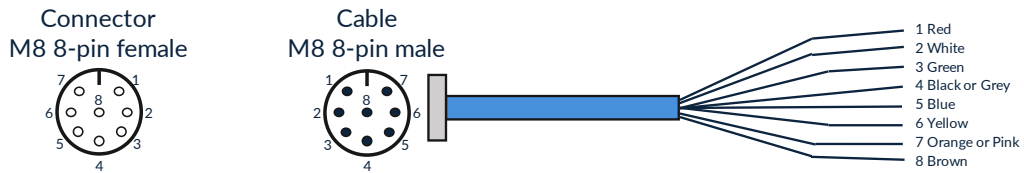

Figure 3.3.: I/O connector pin overview

Pin	Wire color	Symbol	Description
1	Red	CANH	CAN High ¹
2	White	CANL	CAN Low
3	Green	PWR_SHDN	Power shutdown ²
4	Black or Grey	GND	Signal ground
5	Blue	TM_PLS	GNSS1 receiver time pulse
6	Yellow	TM_MRK	GNSS1 receiver time mark
7	Orange or Pink	UART1_RX	UART receiver input 1
8	Brown	UART1_TX	UART transmitter output 1

Table 3.1.: I/O connector pin definition

¹ The user must ensure a termination resistor is on the CAN bus. The cable must be at most 30 cm. If you require a longer cable, you must provide a setup that ensures the integrity of the communication.

² When using the I/O connector, the PWR_SHDN pin should be driven low. To shut down the sensor, drive this pin high (3-12 V). The sensor will only restart when the pin is driven low again. This behavior applies to all sensors with version number 1.2A/B or later (refer to the label on the sensor). For sensors with version numbers 1.0 and 1.1, the pin must be driven high during operation (3.3 V) and can be driven low to reset the sensor.

3.2.4. AUX connector

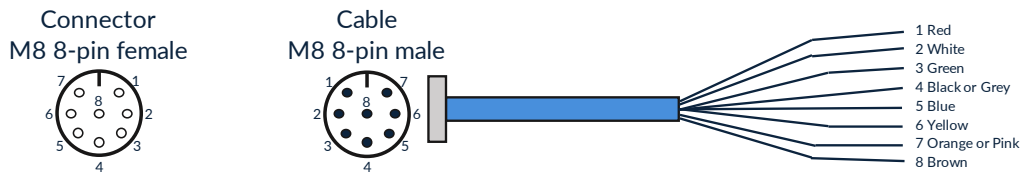

Figure 3.4.: AUX connector pin overview

Pin	Wire color	Symbol	Description
1	Red	+5V	Voltage supply output of 5V
2	White	UART2_RX	UART receiver input 2
3	Green	UART2_TX	UART transmitter output 2
4	Black or Grey	GND	Signal ground
5	Blue	Reserved	Reserved
6	Yellow	Reserved	Reserved
7	Orange or Pink	Reserved	Reserved
8	Brown	Reserved	Reserved

Table 3.2.: Aux connector pin definition

3.2.5. Power connector

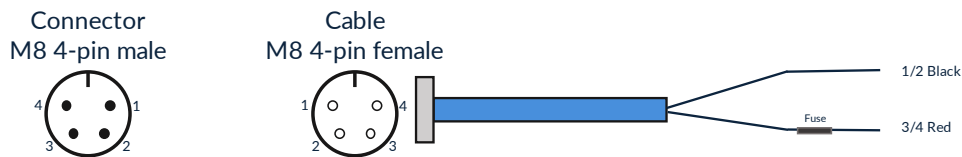

Figure 3.5.: Power connector pin overview

Pin	Wire color	Symbol	Description
1/2	Black	GND	Power ground
3/4	Red	VCC	Main power input

Table 3.3.: Power connector pin definition

3.2.6. GNSS connector

The Vision-RTK 2 contains two GNSS receivers that can connect to an antenna via the female SMA connectors labeled GNSS 1 and GNSS 2.

3.2.7. Wi-Fi connector

The Vision-RTK 2 can significantly increase its Wi-Fi range by connecting a Wi-Fi antenna to the female RP-SMA connector labeled Wi-Fi.

3.2.8. USB (Type-C)

The Vision-RTK 2 contains a USB-C port to connect an external drive for data recording (see Section 5.9). After software version 2.63, the user can also use this port to access the recovery mode. (see Subsection 5.2.5). Note that the USB-C port must only be used as a service interface, not during operation.

3.2.9. Sensor frame

The origin of the sensor's reference frame is on top of the Fixposition logo. Figure 3.6 presents the sensor's reference frame. Note that all the functionalities and messages of the Vision-RTK 2 employ this reference frame by default.

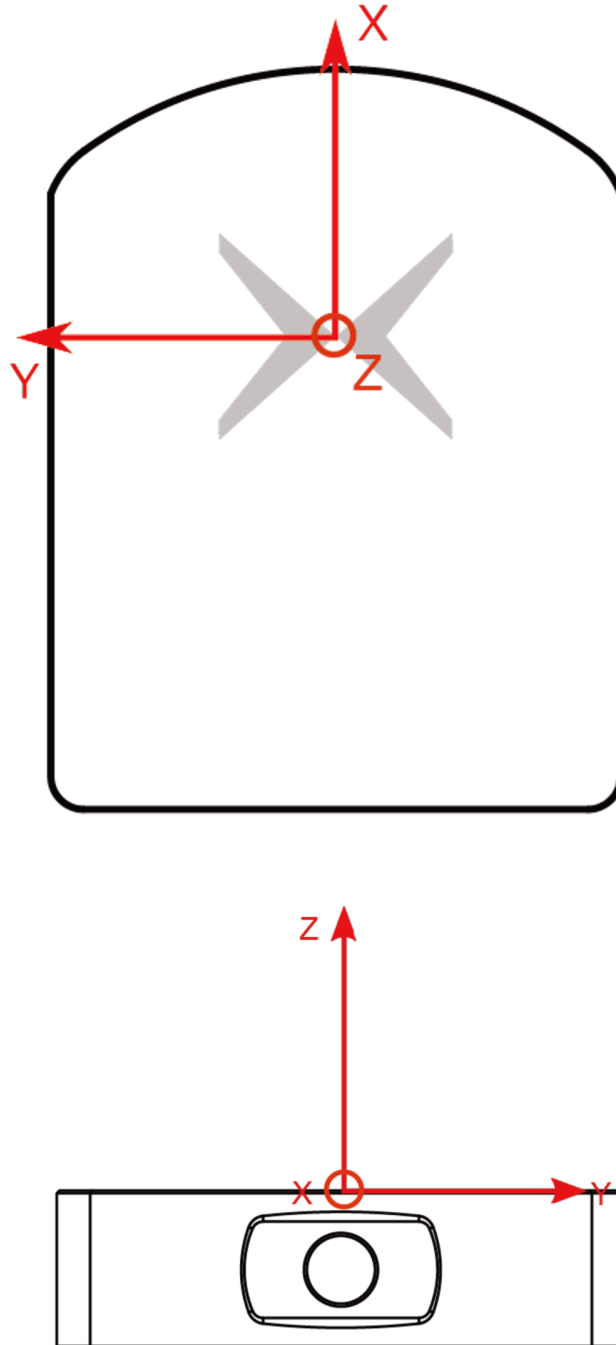

Figure 3.6.: Reference frame of the Vision-RTK 2

3.2.10. Fixposition logo position

Figure 3.7 provides a visual representation of the Fixposition logo's position relative to the boundaries of the sensor's housing. This reference can help measure the extrinsic parameters between Vision-RTK 2 and other components (e.g., GNSS antennas, wheel-speed sensor), especially in cases where the logo is not accessible.

Users can request a STEP file of the sensor's housing to enhance the integration of the Vision-RTK 2 into their platform. This file provides a detailed and comprehensive representation of the sensor's physical design, allowing for seamless integration.

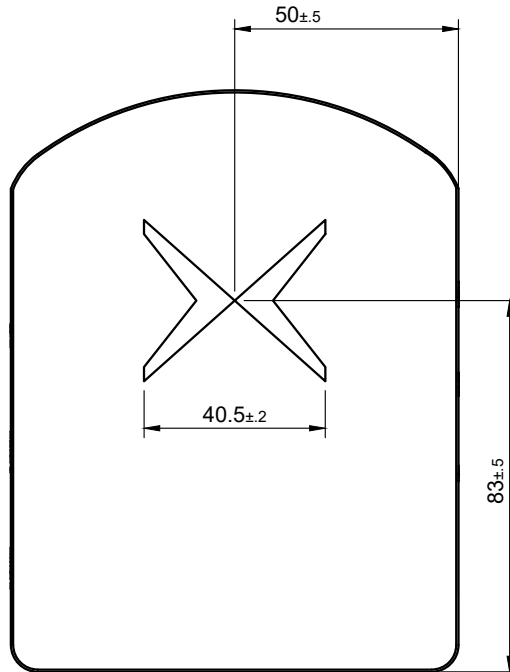

Figure 3.7.: Fixposition logo position on the Vision-RTK 2

3.2.11. Enclosure measurement

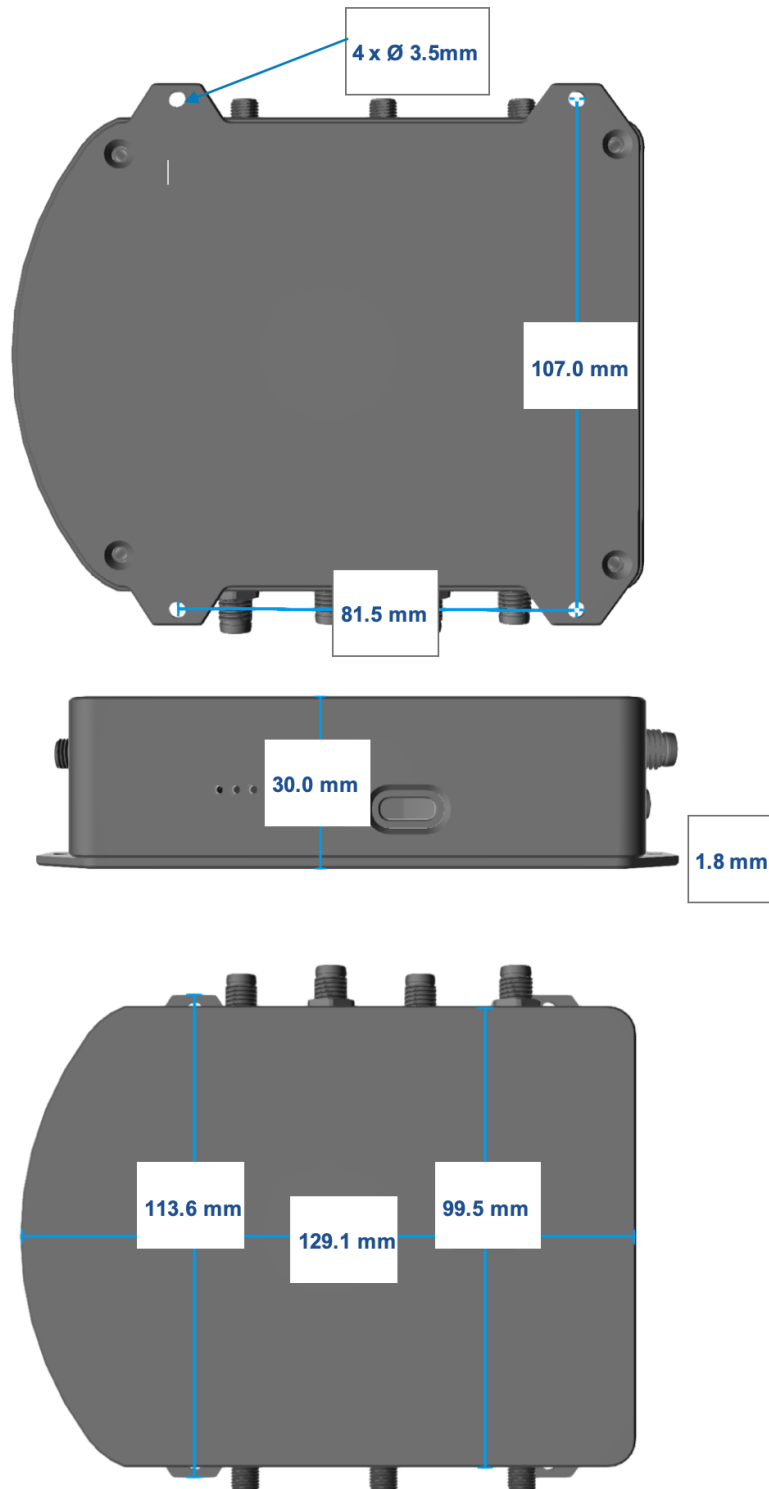

Figure 3.8.: Dimensions of the Vision-RTK 2's enclosure

Installation Guidelines

4.1. Sensor setup requirements

For the proper functioning and optimal performance of the Vision-RTK 2, the user must fulfill the following setup requirements:

- Mount the Vision-RTK 2 firmly/rigidly to the vehicle's body.
- Attach the GNSS antennas to the same rigid body as the Vision-RTK 2, their relative positions must remain unchanged. Please carefully follow the antenna manufacturer's installation guidelines and comply with their requirements to minimize interference.
- Measure the sensor-to-antenna distances with millimeter accuracy (See Figure 4.1). Note that the antenna reference point corresponds to its phase center, described in the corresponding antenna datasheet. The default extrinsic parameters correspond to the measurements of the starter kit.

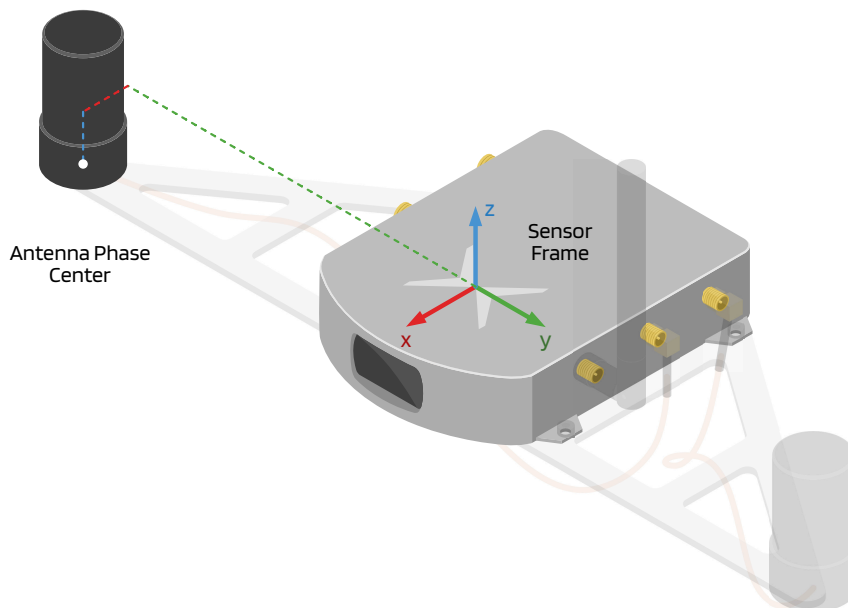

Figure 4.1.: Sensor-to-antenna distance example

- Minimize vibrations experienced by the sensor (e.g., engine, gravel).
- Use shielded cables only and avoid sources of electromagnetic interference near the antennas (e.g., LiDAR, USB3).
- Ensure that the GNSS antennas have an unoccluded view of the sky.
- Employ an external lighting source if working in dim scenarios.
- Reduce static obstructions (e.g., vehicle's structure) and featureless scenes (e.g., sky, mud) in the camera view (See Figure 4.2).



Figure 4.2.: The hood covers almost a third of the frame, preventing feature acquisition.

- We recommend the selected basestation to be less than 15 km from the rover. The sensor might experience degraded performance if the selected RTK basestation is slightly far away (> 15 km). The sensor will experience degraded performance and difficulties computing an RTK-fixed solution if the basestation is excessively far away (> 25 km). In this case, please choose a different NTRIP mountpoint or re-connect to the VRS service.
- GNSS antenna placement with respect to the Vision-RTK 2 sensor can have various impacts on performance. We recommend always placing the sensor at any point between the two GNSS antennas to avoid any lever arms effects or within an ellipse, as shown in Figure 4.3. Ideally, the sensor should be placed on the line between the two antennas. However, due to design considerations (e.g., camera visibility, mounting options), this might not be an option. Therefore, an ellipse that spreads up to 5 cm from the antennas is acceptable.
- A longer baseline between the two GNSS antennas results in better heading estimation. Depending on the sensor's relative positioning, this may also slightly decrease the absolute positioning accuracy. We recommend having a baseline in the 35 cm to 3 meters range, with a minimum supported baseline of about 22 cm.
- Placing the GNSS antennas in the front and back of the sensor allows for slightly better pitch estimation while placing them on the sides for better roll estimation.

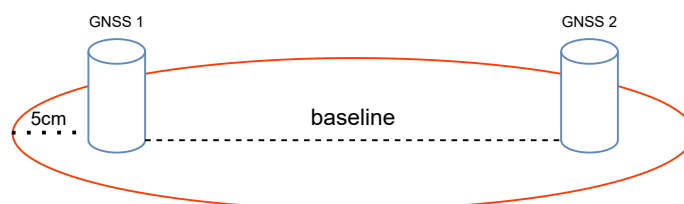

Figure 4.3.: GNSS antenna placement ellipse

4.1.1. Guidelines for antenna selection

For guidance on GNSS antenna selection, please refer to Appendix D. Additionally, Fixposition provides a comprehensive evaluation of different GNSS antennas available on the market at: <https://docs.fixposition.com/fd/gnss-antenna-testing>. These sources are recommended so that the user is able to make an informed decision on the most suitable antenna for their platform.

When selecting an appropriate antenna, the users should pay close attention to the antenna's specifications, especially its input voltage and current requirements. The following guidelines can assist in making an informed decision:

1. **Check the input voltage requirements:** Ensure the antenna's lower limit for the input voltage aligns with the power supply's output. For instance, if an antenna's lower limit is 3.3 V and requires 50 mA, this translates to a power consumption of 165 mW. Given that our supply provides a maximum of 140 mW at 2.8 V, this antenna would be incompatible.
2. **Evaluate the current requirements:** Even if an antenna with a lower voltage limit of 3.3 V requires only 40 mA (equivalent to 132 mW), it might still power up with our 2.8 V supply. However, this scenario is borderline and should be considered out of specification.
3. **Consult the antenna's datasheet:** Most antennas have a detailed datasheet that provides all necessary electrical specifications. Always refer to this document when evaluating compatibility.
4. **Safety first:** Avoid pushing the boundaries of what the power supply can handle. Operating an antenna at its limits can lead to reduced performance or potential damage.

Always ensure that the antenna's power requirements are well within the limits of the Vision-RTK 2's power supply to guarantee optimal performance and longevity.

4.1.2. Powered by Vision-RTK 2

The Vision-RTK 2 can power active GNSS antennas. The power supply is strictly:

2.8V@50mA (max. 140 mW)

The Vision-RTK 2 actively monitors antenna power consumption. To ensure the safety of both the Vision-RTK 2 and GNSS receivers, antenna power is turned off when a short circuit is detected. This detection mechanism functions by capping the current drawn by the antenna. Notably, some antennas may draw excessive current upon startup, inadvertently activating the short circuit detection. The antenna's startup current should not exceed 100mA for durations less than 10ms. If the "Antenna state and power" indicator within the "Status → GNSS" menu doesn't display an **OK and ON** status, users are advised to immediately contact Fixposition for expert guidance on GNSS antenna configuration adjustments.

4.1.3. Powered by external power supply

For antennas with distinct power requirements (in terms of voltage and current), an external power supply is recommended. Utilize an appropriate bias tee, like Minicircuit's ZFBT-4R2G-FT+, in conjunction with a suitable external power source to power these antennas. It's imperative that the chosen external power supply is stable and exhibits minimal noise. Note that when using this setup, the short circuit detection will not be active.

Steps to employ a typical bias tee for external power supply:

- **Connect antenna:** Connect the GNSS antenna to the RF output of the bias tee.
- **Inject DC power:** Connect your DC power source to the DC input of the bias tee. Ensure the voltage and current ratings are compatible with your GNSS antenna's requirements.
- **Connect Vision-RTK 2:** Connect the RF input of the bias tee to the Vision-RTK 2's GNSS1 or GNSS2 connector.
- **Supply power:** Turn on the DC power source to inject power into the RF line and feed the GNSS antenna.

Additionally, the user must comply with the following recommendations:

- Ensure the DC voltage applied is within the specifications of the bias tee and the GNSS antenna.
- Avoid short circuits and ensure proper connections before powering the system.
- Consult the GNSS antenna's datasheet to confirm its power requirements.
- If the user intends to deploy an antenna that falls outside the abovementioned specifications, please consult Fixposition for professional guidance.
- If the "Antenna state and power" indicator does not display an "OK and ON" status within the "Status → GNSS" menu, the user should promptly reach out to Fixposition for professional advice on GNSS antenna setup adjustments.

4.2. Other considerations

- The power supply must deliver 10 W at a 5-36 V voltage. The absolute maximum ratings are -14 V to 40 V, and operating conditions are 4.5 V to 36 V.
- Employ high-quality coaxial cables with minimal signal attenuation and delay with a male SMA connector.
- Select antennas and a correction service that supports L1 and L2 bands for as many satellite constellations as possible (See Appendix D).
- Wheelspeed measurements can improve performance in GNSS outages; however, excessive slippage may be detrimental. Assess whether incorporating this data benefits you.
- Consider the camera FOV data when integrating the sensor (See Appendix C).
- The Vision-RTK 2's performance is not affected by whether the sensor is facing backward or forward in the direction of movement.
- Under ideal conditions, the high-precision GNSS receivers employed by the Vision-RTK 2 can deliver accuracy down to the centimeter level: 0.01 m + 1 ppm circular error probable (CEP) - measured using a 1 km baseline and patch antennas with good ground planes. Thus, if the sensor connects to a base station located 20 km away, the receiver can provide an accuracy of approximately 3 cm. It is worth noting that the degradation rate increases significantly for distances longer than 20 km.

4.3. Maintenance procedure

To ensure the long-lasting adequate performance of the sensor, the user must periodically perform the following steps:

- Clean the camera lens from any obstructions.
- Verify the integrity of all cables.
- Tighten all connections to the sensor.
- Ensure the sensor and the GNSS antennas are firmly attached to the structure and rigid with respect to each other.
- Secure all unused connectors with protective caps (see Figure 4.4).

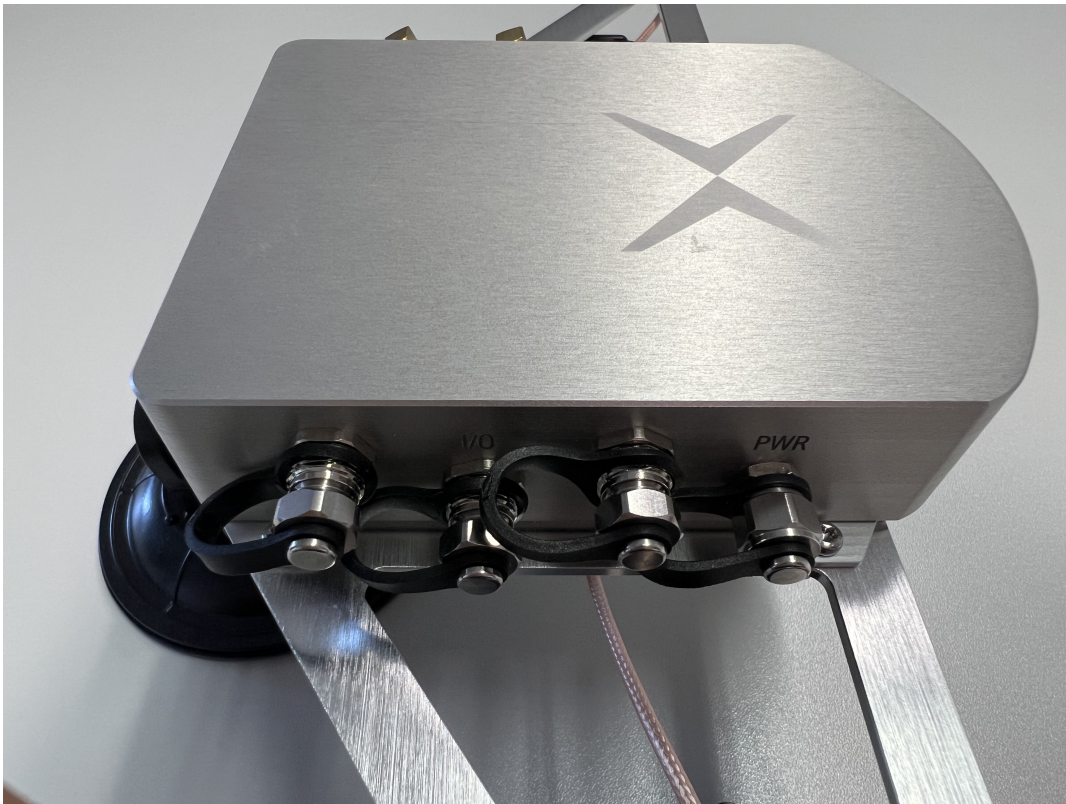

Figure 4.4.: Vision-RTK 2's connectors secured with protective caps

Sensor Configuration

5.1. Web interface overview

To configure the Vision-RTK 2 and visualize the current trajectory, the user can access the web interface through a browser using the IP 10.0.1.1 with a direct Wi-Fi connection or 10.0.2.1 with a direct Ethernet connection. Note that these IP addresses only apply when the sensor is configured as the DHCP server or using its access point directly. Figure 5.1 presents an overview of the web interface content. In the Wi-Fi case, the SSID is the UID of the Vision-RTK 2, and the default password is “1234567890”.

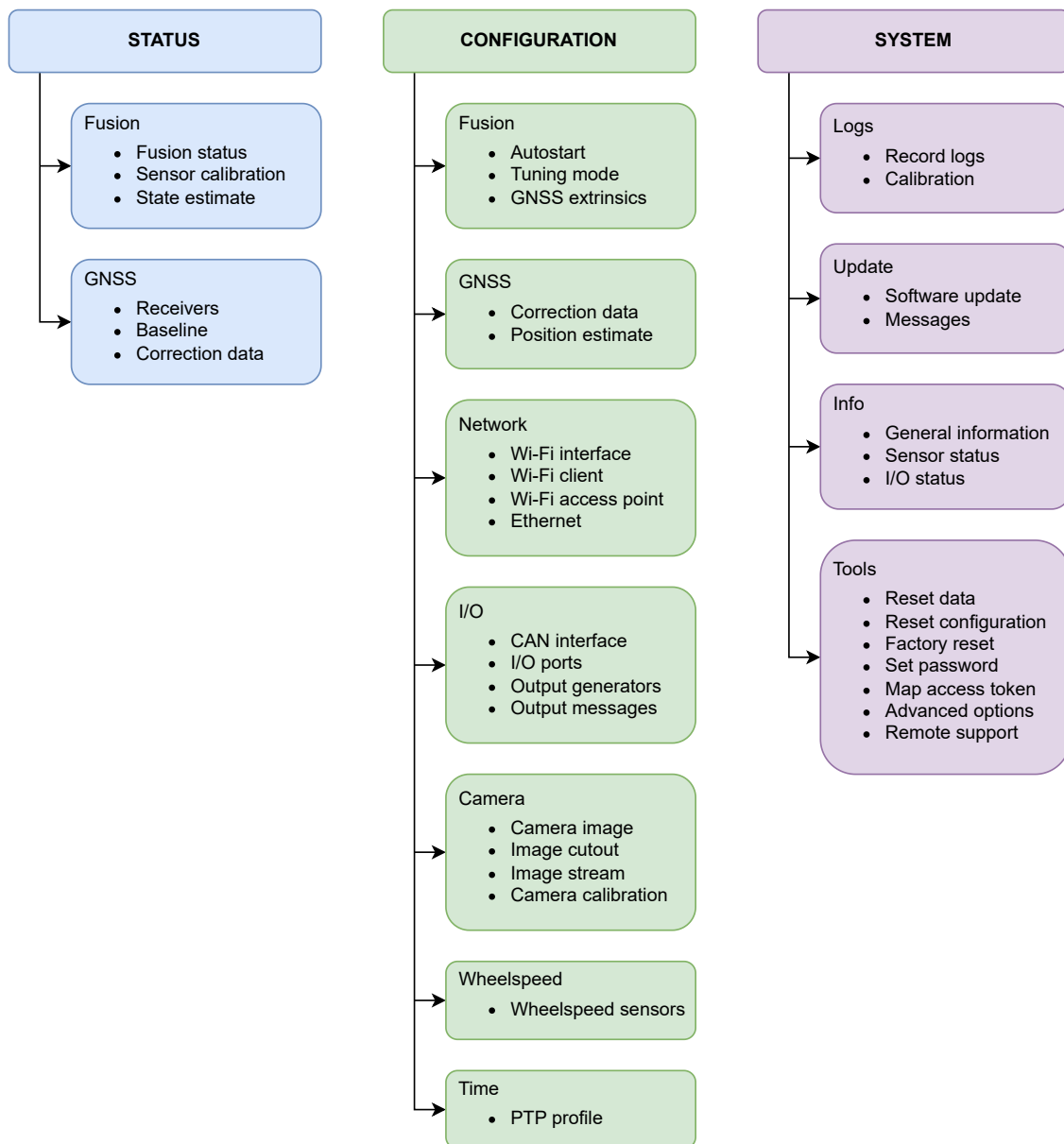

Figure 5.1.: Web interface structure overview

The home page of the web interface is shown in Figure 5.2. The user can access the different configuration options through the navigation bar at the top of the screen, which also contains status indicators to monitor the sensor. Please refer to Subsection 5.13 for more information about the status indicators.

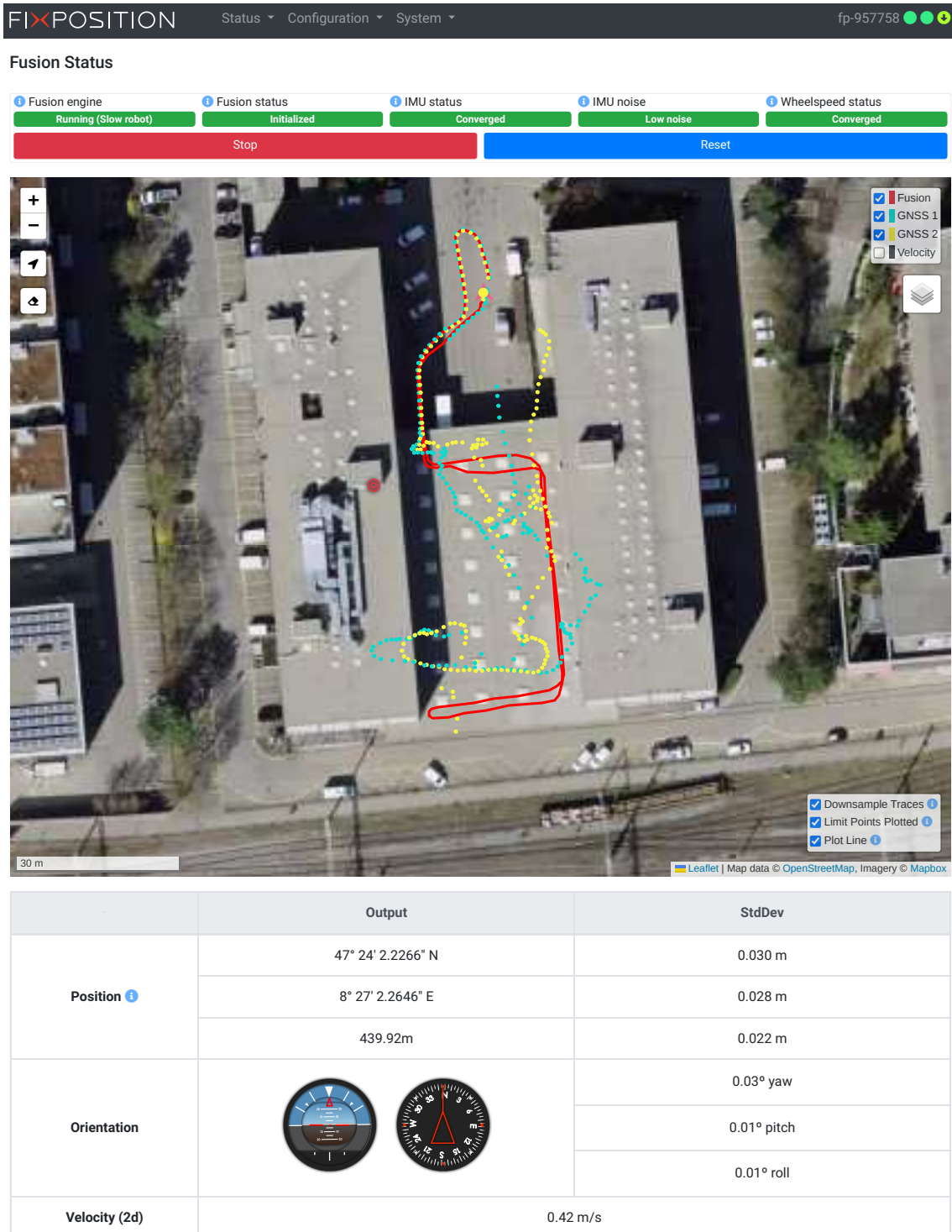

Figure 5.2.: Home page of the web interface

5.2. Network configuration

To access the network configuration page in the web interface, the user must press "Configuration" on the navigation bar and select "Network". As shown in Figure 5.3, this page presents the configuration for the Wi-Fi interface, client, and access point, as well as the Ethernet connection configuration.

The screenshot displays the 'Network Configuration' page in a web interface. At the top, there is a navigation bar with 'FIXPOSITION' on the left, 'Status', 'Configuration', and 'System' dropdown menus in the center, and 'fp-6d9e38' with three status indicators on the right. Below the navigation bar, the page title 'Network Configuration' is visible. The main content area is divided into four sections:

- Wi-Fi interface:** Contains two dropdown menus: 'Wi-Fi band' set to '2.4 GHz (802.11 b/g/n)' and 'Access point' set to 'Enabled'. Below these are two buttons: 'Save and apply' and 'Revert to current'.
- Wi-Fi client:** Shows a 'Connected' status. It lists a connection named 'fixposition' with a 'Connected' status and IP address '192.168.43.12/24'. There are three action icons: a link icon, a refresh icon, and a delete icon. Below the list is an 'Add Wi-Fi connection' button.
- Wi-Fi access point:** Shows a 'Connected' status. It lists a connection named 'access-point' with a 'Connected' status, 'Default' label, and IP address '10.0.1.1/24'. There are two action icons: a link icon and a refresh icon.
- Ethernet:** Shows a 'Default route' and 'Connected' status. It lists three connections: 'dhcp-client' (Connected, Default, 172.22.1.29/20), 'dhcp-server', and 'static-ip'. Each connection has two action icons: a link icon and a refresh icon.

Figure 5.3.: Networking configuration page in the web interface

5.2.1. Network specifications

To connect to a Wi-Fi network and access the Internet, the user must specify the configuration of the Wi-Fi interface, which includes the desired Wi-Fi band and whether the access point of the sensor is enabled. Currently, the sensor supports the 2.4 and 5.0 GHz bands or disabling the Wi-Fi module altogether (see Figure 5.4). After updating the configuration of the Wi-Fi interface, it is necessary to reboot the sensor to apply them. Currently, we only support one band at a time, meaning the access point and the hotspot should operate at the same frequency.

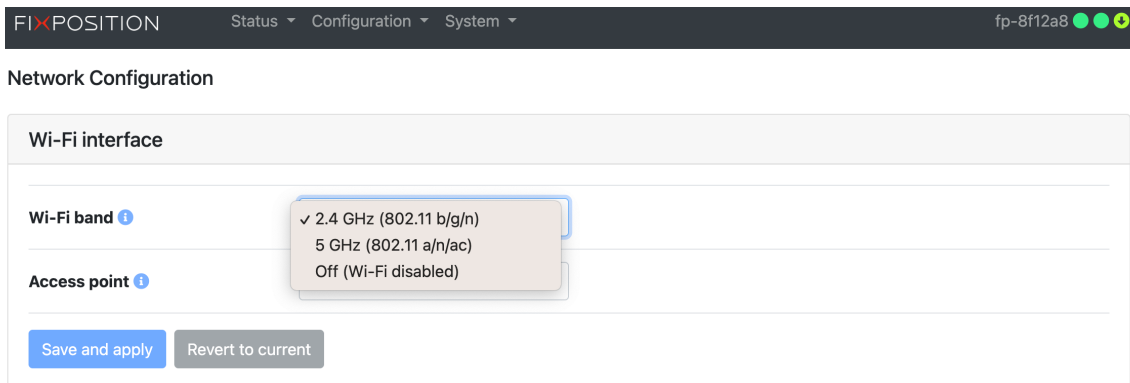

Figure 5.4.: Wi-Fi interface configuration options

The table below summarizes all available network configurations for the Vision-RTK 2:

Network	Sensor IP	Netmask	Client IP	Configuration
Wi-Fi client	Dynamic	Dynamic	n/a	Web interface
Wi-Fi access point	10.0.1.1	255.255.255.0	10.0.1.10–254	Enabled by default
Ethernet DHCP server	10.0.2.1	255.255.255.0	10.0.2.10–254	Enabled by default
Ethernet DHCP client	Dynamic	Dynamic	n/a	Web interface
Ethernet static	Variable	Variable	n/a	Web interface
USB	10.0.3.1	255.255.255.0	10.0.3.10-254	For recovery only

Table 5.1.: Network configuration details

Some details, recommendations, and known limitations to take into consideration:

- Wi-Fi is only suitable as a service interface, as its connection can be unreliable. The device must use Ethernet for regular operation.
- 2.4 GHz is preferred over 5 GHz for Wi-Fi connections due to its range and reliability.
- An Ethernet connection is always prioritized over Wi-Fi for Internet access.
- If the Ethernet is configured as static-ip and it doesn't provide Internet access, make sure to leave the gateway field empty. Only then the Wi-Fi connection will be used for Internet access.
- The only supported Wi-Fi security configuration is "wpa-psk" (WPA2). Currently, we do not support "SAE" (WPA3) nor "open" Wi-Fi connections (no password).
- The Vision-RTK 2 shares Internet access with devices connected to its network.
- The sensor must be configured as a DHCP client when employing an intermediary device, such as a router or access point. Then, the DHCP server in the network is in charge of assigning a dynamic IP address to the sensor. Note that the 10.0.1.1 and 10.0.2.1 IPs do not apply when accessing the sensor via the intermediary device.

- Use distinct SSIDs for each Wi-Fi band (2.4 and 5 GHz) to facilitate connectivity.
- The Vision-RTK 2 will only connect automatically to the network marked as "default" in the web interface. However, marking a new Wi-Fi connection as "default" does not activate this connection automatically; the user must press the "connect" button.
- The IP address, netmask, gateway, and DNS of each connection can be configured.
- Wi-Fi client connections are only partially reliable; they sometimes require multiple attempts to succeed in connecting.
- If the Wi-Fi client connection is lost, reconnecting can take up to two minutes.
- The network SSID must match the regular expression `^[_a-zA-Z0-9]{2,32}$`. In other words, the network SSID must contain only alphanumeric characters.
- The Wi-Fi chip regulatory domain is configured as "passive automatic" (i.e., the chip monitors the existing Wi-Fi channels and uses only those valid in the region).
- Most Wi-Fi 6E access points are configured using 802.11ax by default, which the Vision-RTK 2 does not support. The user must change the configuration to one of our supported bands.

5.2.2. Default route

The default route defines the path network packets take if no specific route is determined. Typically, it relates to the Internet access route, for example, when connected to a Wi-Fi hotspot or plugged into the cable modem/router at home. The table below provides the default route in different configurations and states as the interface over which any network packet going outside will travel. For example, the NTRIP client connection request to an NTRIP caster on the Internet would go over the presented interface.

Note that this table shows that when both the Wi-Fi client and Ethernet (DHCP client or static IP with gateway) have Internet access, the Ethernet route is preferred (i.e., in this context, it means used exclusively). There is no such thing as an automatic retry via another route.

#	Wi-Fi Client	Ethernet	Default route
1	Not configured or not connected	Not configured or not connected	None
2	Configured and connected	Not configured or not connected	Wi-Fi client
3	Configured and connected	Configured (DHCP client) and connected	Ethernet
4	Configured and connected	Configured (DHCP server) and connected	Wi-Fi client
5	Configured and connected	Configured (static IP w/o gateway) and connected	Wi-Fi client
6	Configured and connected	Configured (static IP with gateway) and connected	Ethernet
7	Not configured or not connected	Configured (DHCP client) and connected	Ethernet
8	Not configured or not connected	Configured (DHCP server) and connected	None
9	Not configured or not connected	Configured (static IP w/o gateway) and connected	None
10	Not configured or not connected	Configured (static IP with gateway) and connected	Ethernet

Table 5.2.: Network data ports

This table is valid under the assumption that the external DHCP server (Wi-Fi hotspot or Ethernet router) does provide a default route (i.e., has Internet access). The user can choose not to do that, allowing for various network setup variations.

In this context, "Connected" means the network link is up. It does not mean "Internet" is available (i.e., it does not imply that the upstream connection is good). For example, you can be connected to a Wi-Fi hotspot on your phone even though it is disconnected from the cellular network. In this situation, and with the configuration 1, 4, or 5, it would mean that the device would no longer access the Internet.

Besides the default route, each interface (Wi-Fi client, Wi-Fi access point, Ethernet) has a specific route for that network. Therefore, connections to an address in that network always go via that interface independent of any default route.

The "Configuration → Network" page of the Web Interface shows the current default route as shown in Figure 5.5, where we can see that the Ethernet connection is preferred over the Wi-Fi client.

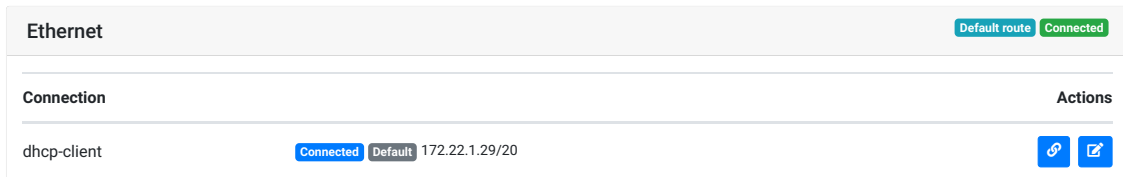

Figure 5.5.: Default route example

5.2.3. Network data ports

The following network data ports are available over Ethernet and Wi-Fi:

Port	Protocol	Clients	Function
21000-21004	Raw TCP/IP socket	Multiple	VRTK data output (\$FP messages) and input (wheelspeed, RTCM3)
23010	Raw TCP/IP socket	Multiple	NTRIP data stream (RTCM3 messages from the NTRIP caster)
80	HTTP	Multiple	Web interface (including software update)
n/a	ICMP	n/a	ICMP traffic (ping, etc.)
53	TCP/UDP	Multiple	Domain (DNS) service, for internet sharing
5353	UDP	Multiple	Multicast DNS
67	TCP/UDP	Multiple	DHCP/Bootstrap Protocol Server
123	UDP	Multiple	NTP time server (Network Time Protocol)
319	UDP	Multiple	PTP Event message
320	UDP	Multiple	PTP General message
21100	HTTP	Single	Network recording

Table 5.3.: Network data ports

Notes:

- The NTP server only provides timing information if the Vision-RTK 2 can access precise time from Internet servers or GNSS.
- Only one simultaneous input stream can be handled correctly on TCP port numbers 21000 – 21004. For example, to input RTCM3 and wheelspeed via the network, use one port (e.g., 21000) for wheelspeed and another (e.g., 21001) for corrections.
- The Vision-RTK 2 rejects connection attempts to any other port.

5.2.4. Outbound connections

The Vision-RTK 2 makes outbound connections to the Internet to the following servers:

- 0.openembedded.pool.ntp.org – NTP time sync.
- Configured NTRIP caster server.

While the web interface is open in a client browser:

- 8.8.8.8 – Checking internet connectivity.

While the camera streaming is enabled:

- Configured RTP uni-/multicasting address and port.

While the Precision Time Protocol (PTP) is enabled:

- PTP multicast messages (e.g., 224.0.1.129 and 224.0.0.107).

While the remote support functionality is enabled:

- reflector.sensor.fixposition.com – Secure reflector server

The web interface (i.e., the client browser, not the Vision-RTK 2 itself) connects to:

- api.mapbox.com - Map data used on the Fusion status page.

5.2.5. USB recovery network

When connected to a PC, the USB port on the Vision-RTK 2 acts as a "USB Ethernet gadget." The PC sees a network interface similar to a USB-to-ethernet dongle.

The PC should automatically detect the network interface and configure it. This way, the user can access the web interface via <http://10.0.3.1> to change the configuration. The configured password does not protect this access mode to the web interface as with other interfaces (Ethernet and Wi-Fi).

The user cannot configure this network access mode as it is only for recovery (e.g., mis-configured Ethernet and Wi-Fi) and should not use it for data transfer.

The USB network interface should automatically work on Linux (e.g., Ubuntu 22.04). Windows should recognize the sensor as a "USB Ethernet/RNDIS Gadget," not as a (non-functional) COM port.

5.2.6. Wi-Fi access point

To change the configuration of the Wi-Fi access point, press the 'Edit connection' button on the Wi-Fi access point section. As shown in Fig. 5.6, the web interface will display a configuration panel where the user can modify the following fields:

- **Password:** Change the Wi-Fi access point password. Leave the field empty so as not to change it. Default: 1234567890.
- **IP address:** Set the IP address for the Wi-Fi access point. Default: 10.0.1.1.
- **Netmask:** Set the network netmask. Default: /24 (255.255.255.0).
- **Broadcast SSID:** Choose if the SSID should be broadcast (normal operation) or not ("hidden" Wi-Fi). Note that a reboot is required to activate changes to this setting. Some computers or phones may still show the (cached) SSID when it is hidden.

The screenshot shows a web interface titled "Edit connection: access-point" with a close button (X) in the top right corner. Below the title, there are four configuration fields, each with an information icon (i) to its left:

- Password:** A text input field containing "Password" and a toggle icon (eye) on the right.
- IP address:** A text input field containing "10.0.1.1".
- Netmask:** A dropdown menu showing "/24 (255.255.255.0)" with a downward arrow icon.
- Broadcast SSID:** A dropdown menu showing "Broadcast SSID" with a downward arrow icon.

At the bottom right of the form, there are two buttons: a grey "Cancel" button and a blue "Apply" button.

Figure 5.6.: Wi-Fi access point configuration on the web interface

5.2.7. Static IP

To set up a static IP for connecting to the Vision-RTK2 over Ethernet, press the 'Edit connection' button on the static IP field of the Ethernet section. As shown in Fig. 5.7, the web interface will display a configuration panel where the user can modify the following fields:

- **IP address:** Set a static IP address for the Vision-RTK2.
- **Netmask:** Set the network netmask. Default: /24 (255.255.255.0).
- **Gateway:** Set the gateway's IP address. Default: 10.0.2.1.
- **DNS:** Set one or more IP addresses of DNS server(s). Default: 1.1.1.1,8.8.8.8,8.8.4.4.
- **Set as default:** Choose if this connection should be the default. Only one connection per interface can be the default.

Press the 'Apply' button to apply the selected changes. At this point, the Vision-RTK2 is not yet using the static IP. Once configured, the user must press the 'Connect' button.

Notes:

- The selected IP address should be in the same subnet as the host machine. Make sure the appropriate netmask is configured.
- Only set this connection as default if this will be the IP for your main setup.
- To provide Internet access to the sensor over Ethernet, the user must set the correct gateway (i.e., the server's IP address).
- The new static IP should be listed if the configuration was successful.
- The connection to the Vision-RTK2 might be lost if the user is already connected to the sensor via Ethernet. The user must establish a new connection with the specified static IP address.

Edit connection: static-ip
×

IP address ⓘ

Netmask ⓘ

Gateway ⓘ

DNS ⓘ

Set as default ⓘ

Cancel
Apply

Figure 5.7.: Static IP configuration on the web interface

5.3. Time synchronization

To visualize which time source the Vision-RTK 2 is employing, head to the "System → Info" page of the web interface and check the "Time synchronization" field. An example is shown in Figure 5.8, where the Vision-RTK 2 is synchronized to the time information provided by the GNSS receivers.

The time information can come from one of the following sources:

- Internal clock.
- Internet Time Service (ITS).
- GNSS time information.

On initialization, the time information provided by the Vision-RTK 2 is based on its internal clock. If an Internet connection is provided, the sensor will attempt to communicate with an Internet Time Service (ITS) to synchronize its clock. Once the sensor receives GNSS signals, its internal clock will synchronize with the atomic clock of the GNSS satellites, which have the highest accuracy. Note that the Vision-RTK 2 has an internal battery to keep its internal clock running without the sensor's power source connected.

Internet connectivity	Active
Time synchronisation	Time synced to GNSS

Figure 5.8.: Time information displayed in the GNSS Status dashboard

In reality, the time kept by clocks in different network devices can drift from each other. In time-sensitive applications, this drift is mitigated by using time synchronization. Having time synchronized between any two clocks means that the difference in time between them has an upper bound. This can be achieved by periodically synchronizing the time between the clocks before the time difference gets too large. There are three options to synchronize another system with the very accurate clock of the Vision-RTK 2: Network Time Protocol (NTP), Pulse Per Second (PPS), and Precise Time Protocol (PTP).

Note: The Vision-RTK 2 operates as an NTP master by default.

5.3.1. Network Time Protocol (NTP)

If a time synchronization precision of a few milliseconds is sufficient, the user can employ the Vision-RTK 2's built-in NTP server (port 123).

Notes:

- The NTP server of the Vision-RTK 2 can provide a clock signal accurate up to the sub-millisecond using a direct Ethernet connection, as the time information provided will be based on GNSS data.
- This is the easiest method to set up, albeit the least accurate.

5.3.2. Precise Time Synchronization (PTP)

If the required time synchronization precision must be in the range of a few microseconds, the user can use the Vision-RTK 2's PTP capabilities. The Ethernet MAC with IEEE 1588 of the Vision-RTK 2 integrates a standard IEEE 802.3 Ethernet MAC with a time-stamping module. The IEEE 1588 standard provides accurate clock synchronization for distributed control nodes (e.g., industrial automation applications). Since VisionRTK 2.81.x, the sensor can be a Precision Time Protocol (PTP) Grand Master (GM). The sensor provides a very precise time (sub-microseconds), which can be used by other devices if required.

Notes:

- The Vision-RTK 2 cannot be synchronized via PTP itself. It only operates as a master and does not act as a slave, i.e. it provides its exact time but does not receive it.
- A lot of knowledge is required to implement PTP correctly in a network. In particular, a lot of time must also be invested to validate the accuracy of the clock synchronization between the involved devices. This can involve a considerable amount of extra work and the purchase of special measuring equipment.
- This method is very accurate and relatively easy to set up. However, verifying if the service is doing what it is supposed to do is hard.

The PTP functionality can be (de)activated in the Web Interface on the "Configuration → Time" page (see Figure 5.9). The following three PTP profiles are supported and can be selected in the Profile drop down menu.

- **PTPv2 E2E (IEEE 1588-2008):** This is the standard PTPv2 profile, which uses the E2E delay mechanism and is specified according to IEEE 1588-2008.
- **gPTP (IEEE 802.1AS):** Also known as Generalized Precision Time Protocol (gPTP), it consists of simplifications and constraints to PTP to optimize it to time-sensitive applications. gPTP also introduces the Grand Master (GM) role which can be played by any node in the gPTP domain (such as end-stations or bridges) and is determined by the Best Master Clock Algorithm (BMCA). The GM provides clocking information to all other nodes in the gPTP domain. gPTP devices operate in one of three roles, according to their location in the spanning tree: master, bridge or slave. The Vision-RTK 2 contains the master clock for the time domain, creates gPTP sync messages, and broadcasts them down-tree to bridge and slave nodes. Bridge nodes forward sync messages to bridge and slave nodes as well. If one or more Ethernet bridges are involved in the customer's network, they must be able to bridge gPTP. This can be implemented with bridges specially designed for this purpose.
- **Avnu automotive profile:** Due to the static nature of the automotive network, AVnu has specified the Automotive Profile which does some optimizations to gPTP to improve startup time and reduce network load. The main difference from gPTP is that the BMCA is disabled so each device is statically assigned as master or slave.

Tests have shown that the precision of the time synchronization with the Vision-RTK 2 using PTP is sub-microsecond. The time accuracy is based on the time provided by the GNSS receiver and is approximately 3us on the sensor with good GNSS reception. During periods of operation when there is no or only degraded GNSS reception, the time provided by PTP will naturally start to drift to the same extent as the time from the GNSS receiver and accuracy may suffer. In other words, under these conditions, PTP will continue to provide the system time and synchronize all connected slaves relative to

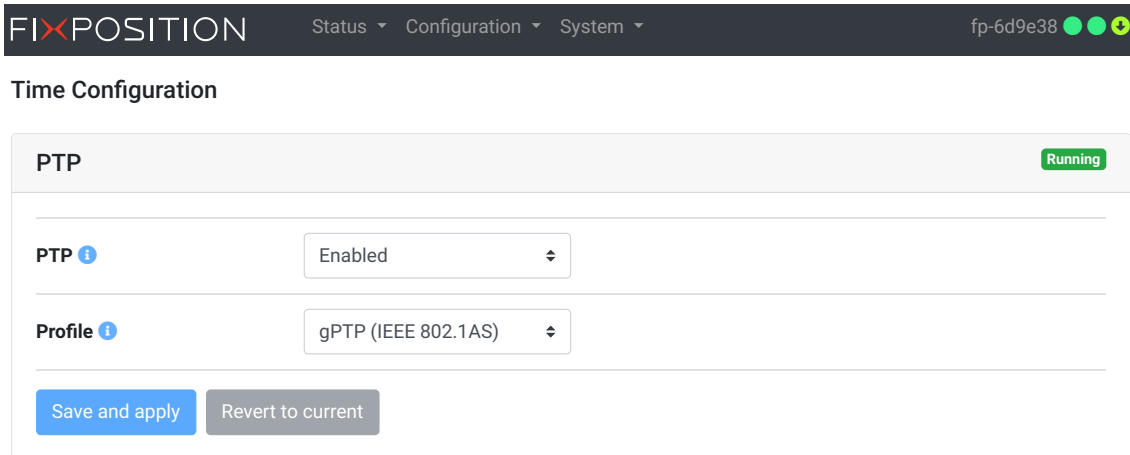

Figure 5.9.: Precise Time Protocol

each other and precision stays the same. However, the time provided may deviate from the global time and accuracy suffers. Note that measurement inaccuracies cannot be precluded. For more precise results, the measurements would have to be carried out again with a more accurate measurement setup.

For examples on how to use the PTP, please refer to <https://docs.fixposition.com/fd/how-to-enable-precision-time-protocol-ntp>.

5.3.3. Pulse Per Second (PPS)

Using PPS with the corresponding timing message from the GNSS receiver provides the maximum accuracy. However, this method is the hardest to set up correctly. The Vision-RTK 2 outputs the PPS signal from the GNSS1 receiver.

- Time pulse over the pin 5 of the I/O connector.
- Time mark over the pin 6 of the I/O connector.

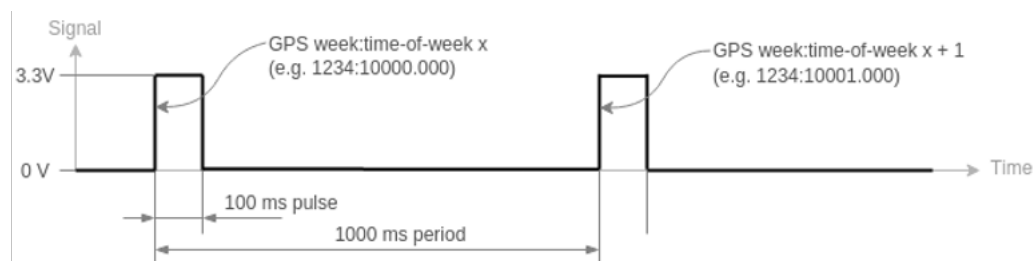

Figure 5.10.: An illustration of time pulse function

Time pulse: The time pulse function provides a one pulse per second (pps) signal. Once the sensor has received any GNSS signal information, the 1 pps signal will adjust to each second, and the rising edge of each pulse will align to the top of GPS time seconds. The duty cycle is 10%, meaning the pulse width is 100 ms. The timestamp message is available in the raw GNSS1 output on port 20010. Some devices require an NMEA-GPRMC message along with the time pulse. If this is the case, please get in touch with Fixposition directly.

Time mark: The time mark accurately measures the time a pulse is detected on pin 6 and outputs a timestamp message on port 20010. At most, the maximum time mark frequency is 5 Hz.

5.4. Input/output system overview

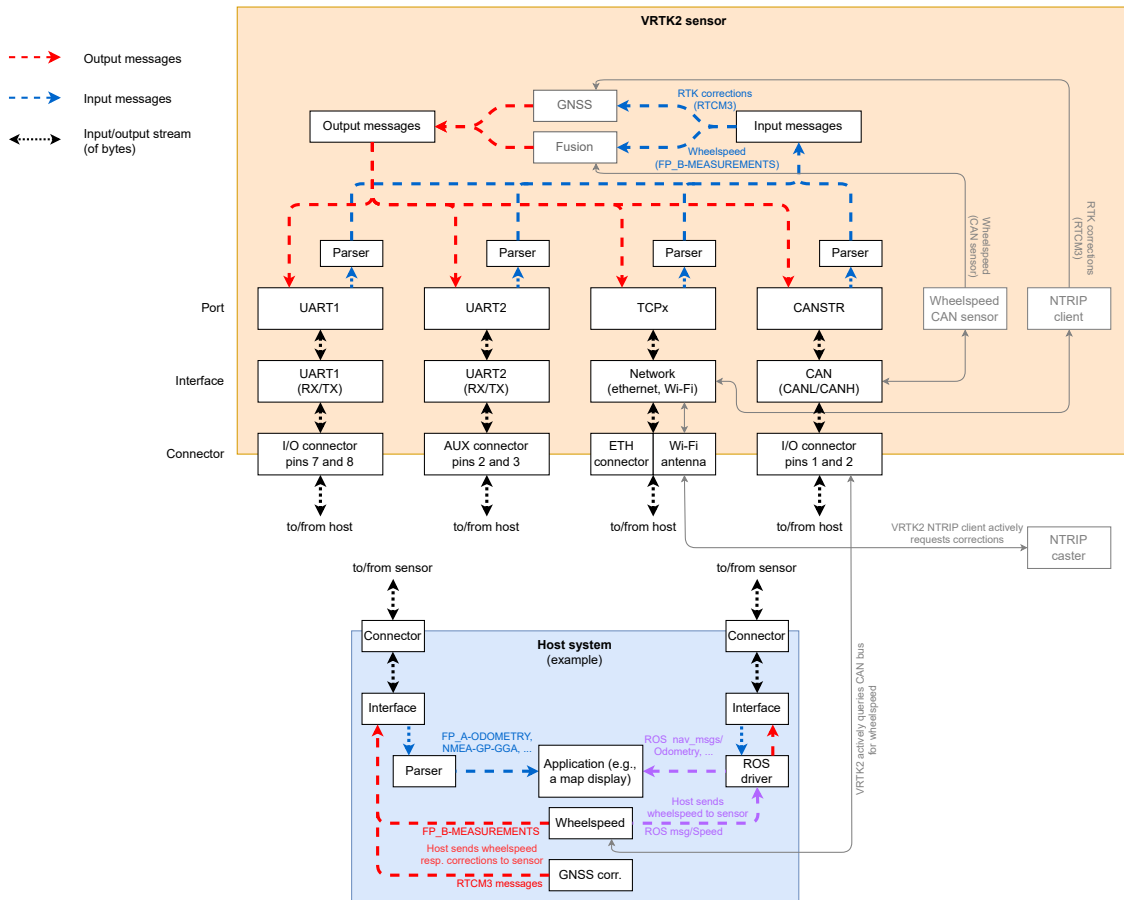

Figure 5.11.: Input/output system overview

The Vision-RTK 2 provides multiple input and output data stream options. This section provides an overview of the I/O system. Note the distinction between:

- **Port:** Physical (e.g., UART) or logical (e.g., network socket) connection endpoint. Via a *connector* and an *interface* this is what the user ultimately connects to.
- **Interface:** Hardware peripheral which connects a *port* with a *connector*.
- **Connector:** Provides the electrical connection to the *interface* (i.e., the connector names are written on the sensor).

The network interfaces of the sensor comprise Ethernet, Wi-Fi station (client), Wi-Fi access point, and USB network. See Section 5.2 for more details on network configuration.

Port	Interface	Connector	Description
UART1	UART1	I/O	(Asynchronous) serial port for speed up to 1 Mbit/s, via a UART1 interface
UART2	UART2	AUX	(Asynchronous) serial port for speed up to 1 Mbit/s, via a UART2 interface
TCP0	Network	Eth, Wi-Fi, USB	TCP/IP raw socket server on port number 21000, can handle multiple clients
TCP1	Network	Eth, Wi-Fi, USB	TCP/IP raw socket server on port number 21001, can handle multiple clients
TCP2	Network	Eth, Wi-Fi, USB	TCP/IP raw socket server on port number 21002, can handle multiple clients
TCP3	Network	Eth, Wi-Fi, USB	TCP/IP raw socket server on port number 21003, can handle multiple clients
TCP4	Network	Eth, Wi-Fi, USB	TCP/IP raw socket server on port number 21004, can handle multiple clients
CANSTR	CAN	I/O	CAN "streaming" port. Broadcasts output messages and listens to incoming messages

Table 5.4.: Connector, Interface, Port overview

Note: The user must not input wheelspeed data and GNSS corrections on the same port simultaneously. The input to a port must be guaranteed (by the user) to be message-by-message. If multiple inputs to the same port are provided (e.g., GNSS corrections and wheelspeed), then the user must ensure that the messages are not interleaved on the byte level (which would corrupt the message frames). Alternatively, the user can use two ports independently: input GNSS corrections on one port (e.g., TCP0) and wheelspeed measurements on another (e.g., TCP1).

5.4.1. UART port configuration

The UART1 and UART2 ports correspond to the pins 7 (UART1_RX), 8 (UART1_TX), 4 (GND) in the I/O connector, and pins 2 (UART2_RX), 3 (UART2_TX), and 4 (GND) in the AUX connector (see Subsection 3.2 for more information). The user can configure the baud rate of the UART ports inside the "Configuration → I/O" panel of the ieb interface. The available options are 9'600, 19'200, 38'400, 57'600, 115'200, 230'400, 460'800, or 921'600. A baud rate of 115'200 or higher is recommended.

The user can input the wheelspeed sensor and RTCM3 correction data streams into the Vision-RTK 2 via UART (see Section 5.7 and Section 5.5, respectively). The Vision-RTK can stream the output messages (e.g., FP odometry) via UART (see Subsection 5.4.5).

The screenshot shows the "I/O ports" configuration panel. Under the "UART1" section, the "Baudrate" is set to "115'200". Under the "UART2" section, the "Baudrate" is also set to "115'200". Each setting has an information icon (i) to its left.

Figure 5.12.: UART baud rate configuration

5.4.2. CAN streaming port configuration

All input and output ports are streams of bytes (uint8_t). The CANSTR port packs the output stream of bytes into as many CAN frames as necessary. Depending on the CANSTR configuration, this can be classical CAN frames with up to 8 bytes or CAN FD frames with up to 64 bytes of payload. Figure 5.13 shows the CANSTR message format generation. The CANSTR port corresponds to the pins 1 (CANH), 2 (CANL), and 4 (GND) of the I/O connector (see Table 3.1).

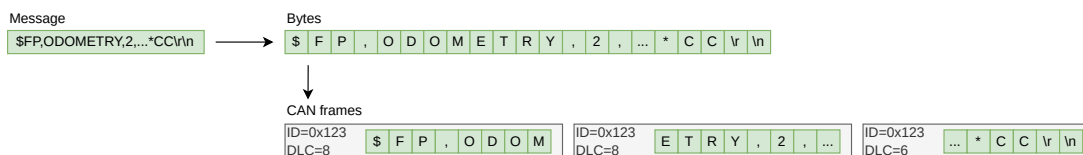

Figure 5.13.: CANSTR message format

The user can configure the CAN interface inside the "Configuration → I/O" panel of the web interface, as shown in Figure 5.14. The following configuration options are available:

- **CAN interface:** The CAN interface can be enabled or disabled.

- **Classical CAN bitrate:** The bitrates [Hz] can be: 10'000, 20'000, 50'000, 125'000, 250'000, 500'000, 800'000 or 1'000'000.
- **CAN FD (BRS) bitrate:** The CAN FD bitrate must be greater or equal to the classical CAN bitrate.

The user must reboot the sensor after updating the CAN interface configuration.

I/O Configuration

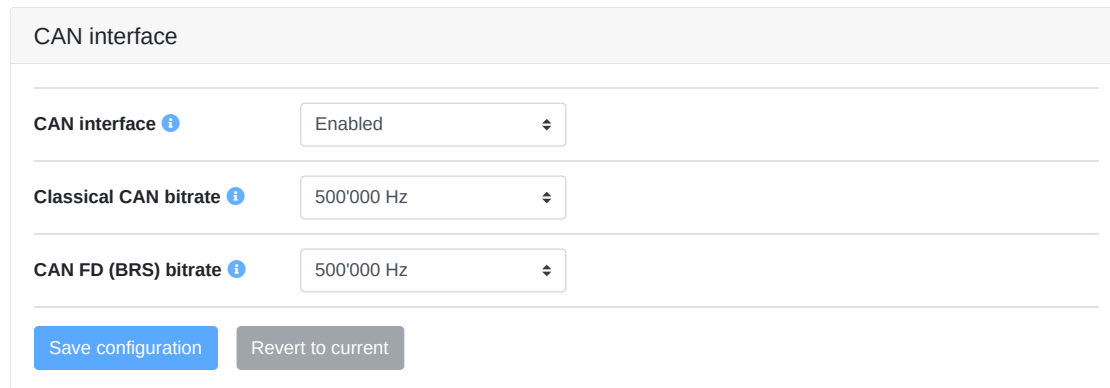

CAN interface

CAN interface ⓘ Enabled ▾

Classical CAN bitrate ⓘ 500'000 Hz ▾

CAN FD (BRS) bitrate ⓘ 500'000 Hz ▾

Save configuration Revert to current

Figure 5.14.: CAN interface configuration

The CANSTR module configuration can be modified in the CANSTR panel inside the "Configuration → I/O" panel of the web interface, as shown in Figure 5.15. The following configuration options are available:

- **CAN ID output:** CAN ID for outgoing CAN frames.
 - Standard frame format (SFF): 11-bit value in the range 0x001 - 0x1ff.
 - Extended frame format (EFF): 29-bit value in the range 0x00000001 - 0x1fffffff.
- **CAN ID input:** CAN ID for incoming CAN frames.
 - Standard frame format (SFF): 11-bit value in the range 0x001 - 0x1ff.
 - Extended frame format (EFF): 29-bit value in the range 0x00000001 - 0x1fffffff.
- **CAN frame format:** CAN frame format used by the connector.
 - Standard frame format (SFF): Use 11-bit CAN IDs for input and output.
 - Extended frame format (EFF): Use 29-bit CAN IDs for input and output.
- **CAN FD:** Classical CAN or CAN flexible data rate (FD)
 - Classical CAN: CAN frames of up to 8 bytes payload.
 - CAN FD: CAN frames of up to 64 bytes of payload.
- **CAN FD BRS:** Enable bitrate switching (BRS) when using CAN FD.
 - Enabled: Use CAN FD BRS.
 - Disabled: Do not use CAN FD BRS.

5.4.3. Differences between CANSTR and CAN Interface

CANSTR, as defined by Fixposition, is a specialized port built upon the standard CAN interface. It offers the flexibility to utilize the CAN protocol to stream input and output data, which the user can customize within the I/O configuration section of the web interface. Additionally, the user can configure the CAN ID for these streams as required.

The main distinctions between CANSTR and the traditional CAN interface are:

- The Vision-RTK 2 natively recognizes the Classic CAN message with ID: 0x146 for wheelspeed input when using the adequately configured payload (see <https://docs.fixposition.com/fd/fixposition-can-frame>). For more details on configuring the wheelspeed input via CAN, please refer to Section 5.7.1.
- CANSTR allows for a more customized approach. Users can assign a specific ID and embed customized data within the payload of either Classic CAN or CAN FD. You can also put FP_B-MEASUREMENTS information into the payload. This setup is analogous to the UART/TCP mechanism, especially when streaming wheelspeed data into the system. Moreover, CANSTR provides the capability to input and output other user-defined information.

A vital consideration when working with any CAN interface is the bitrate setting. Ensuring the correct bitrate is paramount for the seamless communication of all devices on the CAN bus.

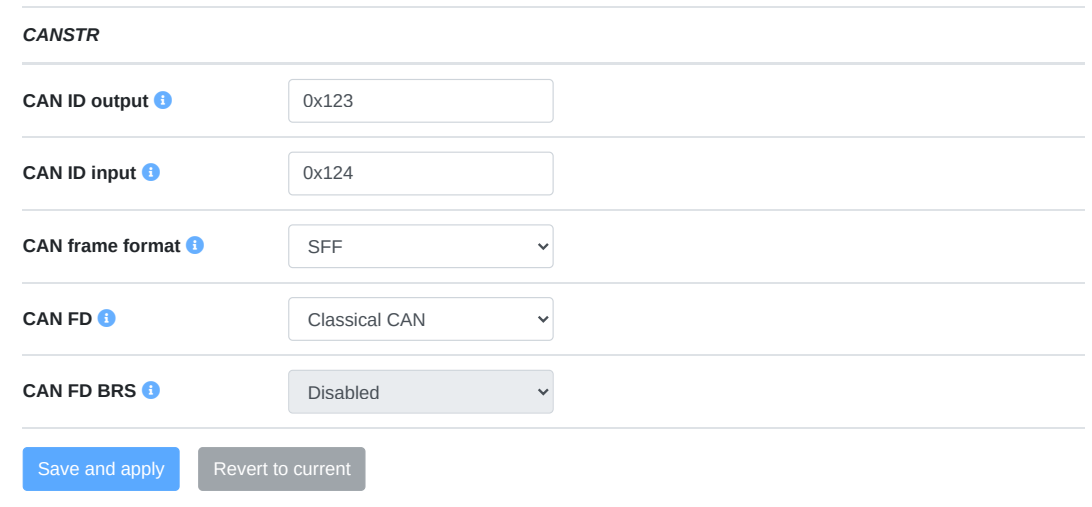

CANSTR	
CAN ID output ⓘ	<input type="text" value="0x123"/>
CAN ID input ⓘ	<input type="text" value="0x124"/>
CAN frame format ⓘ	<input type="text" value="SFF"/>
CAN FD ⓘ	<input type="text" value="Classical CAN"/>
CAN FD BRS ⓘ	<input type="text" value="Disabled"/>
<input type="button" value="Save and apply"/> <input type="button" value="Revert to current"/>	

Figure 5.15.: CANSTR module configuration

5.4.4. Output generator

The user can configure the Fusion output at the Output generators module inside the "Configuration → I/O" panel of the web interface, as shown in Figure 5.16. The following configuration options are available:

- **Fusion output frequency:** Rate in [Hz] at which the Fusion generates its output. Range: 1-100.
- **Fusion output offset:** Specifies how much time ahead Fusion calculates its output [s], compensating for output or processing latency (at the cost of some accuracy). Range: 0.0-0.2.
- **TF output frequency:** Output frequency in [Hz] for the TF output. Range: 1-10.
- **NMEA output format:** NMEA format used by the Fusion output.
 - Strict NMEA: Strictly follow the NMEA specifications.
 - High-Precision: Enable output of non-standard data fields with more precision.
- **Output Point of Interest configuration:** Parameters to transform the output from the sensor frame to the Point of Interest (POI); see Section 5.12 for more details.
 - Output translation: Translation vector in [m] from the sensor frame to the POI. This translation is defined with respect to the fixed reference frame of the sensor. Range: -100.0-100.0.
 - Output rotation: Rotation from the sensor frame to the POI using ZYX Euler angles (yaw-pitch-roll) in degrees. It employs intrinsic rotations (i.e., the reference frame is updated after each subsequent rotation). Range: -180.0-180.0°.

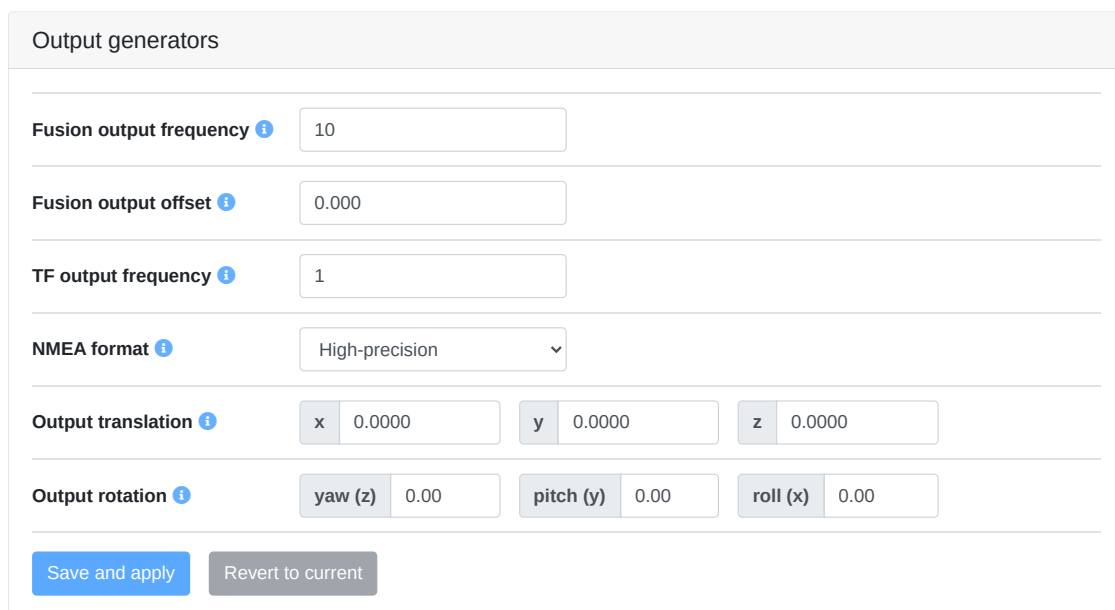

Output generators

Fusion output frequency ⓘ 10

Fusion output offset ⓘ 0.000

TF output frequency ⓘ 1

NMEA format ⓘ High-precision ▾

Output translation ⓘ x 0.0000 y 0.0000 z 0.0000

Output rotation ⓘ yaw (z) 0.00 pitch (y) 0.00 roll (x) 0.00

Save and apply Revert to current

Figure 5.16.: Output generators configuration

Note: With High-Precision enabled, the output is no longer NMEA compliant. See the comparison of the two modes in Table 5.5. If you are currently parsing standard NMEA formatted messages, you must update your parser to support the added digits for the "High-Precision" NMEA output provided.

Field	Strict NMEA	High-precision	Notes
Latitude, Longitude (degrees)	ddmm.mmmmm [~ 20 mm]	ddmm.mmmmmmm [~ 0.2 mm]	Approximate, worst case (at the equator)
Height, Altitude (meters)	float(.1) [100 mm]	float(.4) [0.1 mm]	
Time (seconds)	ss.ss [10 ms]	ss.ssss [0.1 ms]	
Speed (knots)	float(.1) [~ 100 mm/s]	float(.5) [~ 0.1 mm/s]	
Heading, Course (degrees)	float(.1) [0.1 deg]	float(.4) [0.0001 deg]	
Number of satellites	00..12	00..99	

Table 5.5.: Strict(standard) and High-precision NMEA format comparison

5.4.5. Output messages configuration

The user can select which messages are assigned to each port at the "Output messages" module inside the "Configuration → I/O" panel, as shown in Figure 5.18.

Fusion output: The output frequency of these messages is the same as the Fusion output frequency configured in the output generator (See Subsection 5.4.4). By default, the output frequency is 10 Hz, but the user can configure it to the range of 1-100 Hz. For a detailed list of all available messages, their formats, and examples, please refer to <https://docs.fixposition.com/fd/i-o-messages>.

Available Fusion messages:

- FP_A-ODOMETRY
- FP_A-ODOMENU
- FP_A-ODOMSH*
- FP_A-TF_ECEFENU0
- FP_A-TF_POIPOISH*
- FP_A-LLH
- NOV_B-INSPVAX
- NOV_B-BESTVEL_FUSION
- NMEA-GP-GGA_FUSION
- NMEA-GN-GSA_FUSION
- NMEA-GP-GLL_FUSION
- NMEA-GP-GST_FUSION
- NMEA-GX-GSV_FUSION
- NMEA-GP-HDT_FUSION
- NMEA-GP-RMC_FUSION
- NMEA-GP-VTG_FUSION
- NMEA-GP-ZDA_FUSION

* The smooth odometry output aims to provide a smooth trajectory without jumps, allowing users to use the Vision-RTK 2 for control applications (e.g., motor feedback). For more information, refer to Docs: Smooth odometry.

IMU output: All IMU output is generated at the IMU frequency of approximately 200 Hz. Note that the IMU output requires a lot of output bandwidth. For example, on a serial port, the baud rate must be set high enough for the necessary bandwidth. The exact number depends on what messages are enabled for the port.

Available IMU messages:

- FP_A-RAWIMU
- FP_A-CORRIMU
- FP_A-TF_POIIMUH
- NOV_B-RAWIMU

TF output: The output frequency of these messages is the same as the TF output frequency configured in the output generator (See Subsection 5.4.4). By default, the output frequency is 1 Hz, but the user can configure it to the range of 1-10 Hz.

Available TF messages:

- FP_A-TF_VRTKCAM
- FP_A-TF_POIVRTK

Text output: Irregular output of text messages (strings). There are four levels:

- **ERROR** – An error is something from which the sensor cannot recover or something that renders the sensor unusable in normal circumstances.
- **WARNING** – A warning is something from which the sensor could recover or that does not render the sensor unusable in normal circumstances (i.e., the sensor operated to specifications). But it can, for example, hint at degraded performance.
- **INFO** – General information.
- **DEBUG** – Debug information valuable to the Fixposition team.

For example, the sensor outputs a "boot screen" on boot. While it does output it to any port where the **FP_A-TEXT_INFO** message is enabled, it is only practical to observe this output on UART and CANSTR ports. It is not possible to connect to the TCP ports in time to observe this output.

The boot screen is as follows:

```
$FP,TEXT,1,INFO,Fixposition AG - www.fixposition.com*09\r\n
$FP,TEXT,1,INFO,SW=fp_release_vr2_2.61.0_191*78\r\n
$FP,TEXT,1,INFO,HW=nav-vr2 1.2a 6d9d18*3E\r\n
```

Available text messages:

- FP_A-TEXT_ERROR
- FP_A-TEXT_WARNING
- FP_A-TEXT_INFO
- FP_A-TEXT_DEBUG

GNSS output: All GNSS output is generated by default at the GNSS frequency of approximately 5 Hz. In addition, some GNSS output messages cannot be distinguished between GNSS receivers; ensure you use different ports to avoid confusion.

Available GNSS messages:

- NMEA-GP-GGA_GNSS[average, 1, 2]
- NMEA-GP-GLL_GNSS[average, 1, 2]
- NMEA-GN-GSA_GNSS[average, 1, 2]
- NMEA-GP-GST_GNSS[average, 1, 2]

- NMEA-GX-GSV_GNSS[average, 1, 2]
- NMEA-GP-RMC_GNSS[average, 1, 2]
- NMEA-GP-VTG_GNSS[average, 1, 2]
- NMEA-GP-ZDA_GNSS[average, 1, 2]
- NOV_B-BESTGNSSPOS_GNSS[1,2]
- NOV_B-HEADING2
- FP_A-GNSSANT
- FP_A-GNSSCORR
- NMEA-GP-GGA_NTRIP
- NMEA-GP-GGA_GNSS1TOS
- NMEA-GP-RMC_GNSS1TOS

In the advanced view, each available message shows its output rate. Zero (0) means the message is disabled and is not output. One (1) means the message is enabled, and its output frequency is 1 Hz. Values greater than one indicate that one of every n-th message is output (e.g., Five (5) means only one of every five messages is output).

While values other than 0 or 1 may not make sense for most messages or scenarios, there are use cases for these values. For example, we can configure the Fusion output to 50 Hz and enable the **FP_A-ODOMETRY** output on TCP0. Enabling this message implies a rate of 1 by default; thus, its output is also at 50 Hz. This high output rate would not be possible on a low-bandwidth port, such as UART. However, the user can select a rate of 10, meaning the sensor would output only every tenth message (i.e., 5 Hz), for which the bandwidth is sufficient.

Note that there is no guarantee for output rates greater than one to be aligned to the top of the second. For example, for a message generated at 10 Hz, with a rate of 5, the sensor cannot guarantee the time stamps to end in x.0 and x.5, as a slight delay could change the timings to x.1 and x.6 or x.4 and x.9.

In Figure 5.17, the output rate is 10 for the **FP_A-ODOMETRY** message on the UART1 port. If the desired output frequency is 100 Hz, the actual output frequency is equal to or smaller than 10 Hz.

$$\text{real output frequency} \leq \text{theoretical output frequency} = \frac{\text{Fusion output frequency}}{\text{output rate}}$$

Output messages
i

Fusion output i	UART1	UART2	TCP0	TCP1	TCP2	TCP3	TCP4	CANSTR
FP_A-ODOMETRY	<input style="width: 30px;" type="text" value="10"/>	<input style="width: 30px;" type="text" value="0"/>	<input style="width: 30px;" type="text" value="1"/>	<input style="width: 30px;" type="text" value="0"/>	<input style="width: 30px;" type="text" value="0"/>	<input style="width: 30px;" type="text" value="0"/>	<input style="width: 30px;" type="text" value="0"/>	<input style="width: 30px;" type="text" value="0"/>

Figure 5.17.: An example of setting up the output rate

Output messages
i

Fusion output i

FP_A-ODOMETRY	<input checked="" type="checkbox"/> UART1	<input type="checkbox"/> UART2	<input checked="" type="checkbox"/> TCP0	<input type="checkbox"/> TCP1	<input type="checkbox"/> TCP2	<input type="checkbox"/> TCP3	<input type="checkbox"/> TCP4	<input type="checkbox"/> CANSTR
FP_A-LLH	<input type="checkbox"/> UART1	<input type="checkbox"/> UART2	<input type="checkbox"/> TCP0	<input type="checkbox"/> TCP1	<input type="checkbox"/> TCP2	<input type="checkbox"/> TCP3	<input type="checkbox"/> TCP4	<input type="checkbox"/> CANSTR
NOV_B-INSPVAX	<input type="checkbox"/> UART1	<input type="checkbox"/> UART2	<input type="checkbox"/> TCP0	<input type="checkbox"/> TCP1	<input type="checkbox"/> TCP2	<input type="checkbox"/> TCP3	<input type="checkbox"/> TCP4	<input type="checkbox"/> CANSTR
NMEA-GP-GGA_FUSION	<input type="checkbox"/> UART1	<input type="checkbox"/> UART2	<input type="checkbox"/> TCP0	<input type="checkbox"/> TCP1	<input type="checkbox"/> TCP2	<input type="checkbox"/> TCP3	<input type="checkbox"/> TCP4	<input type="checkbox"/> CANSTR
NMEA-GP-HDT_FUSION	<input type="checkbox"/> UART1	<input type="checkbox"/> UART2	<input type="checkbox"/> TCP0	<input type="checkbox"/> TCP1	<input type="checkbox"/> TCP2	<input type="checkbox"/> TCP3	<input type="checkbox"/> TCP4	<input type="checkbox"/> CANSTR

IMU data i

FP_A-RAWIMU	<input type="checkbox"/> UART1	<input type="checkbox"/> UART2	<input type="checkbox"/> TCP0	<input type="checkbox"/> TCP1	<input type="checkbox"/> TCP2	<input type="checkbox"/> TCP3	<input type="checkbox"/> TCP4	<input type="checkbox"/> CANSTR
FP_A-CORRIMU	<input type="checkbox"/> UART1	<input type="checkbox"/> UART2	<input type="checkbox"/> TCP0	<input type="checkbox"/> TCP1	<input type="checkbox"/> TCP2	<input type="checkbox"/> TCP3	<input type="checkbox"/> TCP4	<input type="checkbox"/> CANSTR
NOV_B-RAWIMU	<input type="checkbox"/> UART1	<input type="checkbox"/> UART2	<input type="checkbox"/> TCP0	<input type="checkbox"/> TCP1	<input type="checkbox"/> TCP2	<input type="checkbox"/> TCP3	<input type="checkbox"/> TCP4	<input type="checkbox"/> CANSTR
FP_A-TF_POIIMUH	<input type="checkbox"/> UART1	<input type="checkbox"/> UART2	<input type="checkbox"/> TCP0	<input type="checkbox"/> TCP1	<input type="checkbox"/> TCP2	<input type="checkbox"/> TCP3	<input type="checkbox"/> TCP4	<input type="checkbox"/> CANSTR

TF output i

FP_A-TF_VRTKCAM	<input checked="" type="checkbox"/> UART1	<input type="checkbox"/> UART2	<input checked="" type="checkbox"/> TCP0	<input type="checkbox"/> TCP1	<input type="checkbox"/> TCP2	<input type="checkbox"/> TCP3	<input type="checkbox"/> TCP4	<input type="checkbox"/> CANSTR
FP_A-TF_POIVRTK	<input checked="" type="checkbox"/> UART1	<input type="checkbox"/> UART2	<input checked="" type="checkbox"/> TCP0	<input type="checkbox"/> TCP1	<input type="checkbox"/> TCP2	<input type="checkbox"/> TCP3	<input type="checkbox"/> TCP4	<input type="checkbox"/> CANSTR

Text info i

FP_A-TEXT_ERROR	<input checked="" type="checkbox"/> UART1	<input checked="" type="checkbox"/> UART2	<input checked="" type="checkbox"/> TCP0	<input checked="" type="checkbox"/> TCP1	<input checked="" type="checkbox"/> TCP2	<input checked="" type="checkbox"/> TCP3	<input checked="" type="checkbox"/> TCP4	<input checked="" type="checkbox"/> CANSTR
FP_A-TEXT_WARNING	<input checked="" type="checkbox"/> UART1	<input checked="" type="checkbox"/> UART2	<input checked="" type="checkbox"/> TCP0	<input checked="" type="checkbox"/> TCP1	<input checked="" type="checkbox"/> TCP2	<input checked="" type="checkbox"/> TCP3	<input checked="" type="checkbox"/> TCP4	<input checked="" type="checkbox"/> CANSTR
FP_A-TEXT_INFO	<input checked="" type="checkbox"/> UART1	<input checked="" type="checkbox"/> UART2	<input checked="" type="checkbox"/> TCP0	<input checked="" type="checkbox"/> TCP1	<input checked="" type="checkbox"/> TCP2	<input checked="" type="checkbox"/> TCP3	<input checked="" type="checkbox"/> TCP4	<input checked="" type="checkbox"/> CANSTR
FP_A-TEXT_DEBUG	<input type="checkbox"/> UART1	<input type="checkbox"/> UART2	<input type="checkbox"/> TCP0	<input type="checkbox"/> TCP1	<input type="checkbox"/> TCP2	<input type="checkbox"/> TCP3	<input type="checkbox"/> TCP4	<input type="checkbox"/> CANSTR

GNSS data i

NMEA-GP-GGA_GNSS	<input type="checkbox"/> UART1	<input type="checkbox"/> UART2	<input type="checkbox"/> TCP0	<input type="checkbox"/> TCP1	<input type="checkbox"/> TCP2	<input type="checkbox"/> TCP3	<input type="checkbox"/> TCP4	<input type="checkbox"/> CANSTR
NMEA-GP-GGA_GNSS1	<input type="checkbox"/> UART1	<input type="checkbox"/> UART2	<input type="checkbox"/> TCP0	<input type="checkbox"/> TCP1	<input type="checkbox"/> TCP2	<input type="checkbox"/> TCP3	<input type="checkbox"/> TCP4	<input type="checkbox"/> CANSTR
NMEA-GP-GGA_GNSS2	<input type="checkbox"/> UART1	<input type="checkbox"/> UART2	<input type="checkbox"/> TCP0	<input type="checkbox"/> TCP1	<input type="checkbox"/> TCP2	<input type="checkbox"/> TCP3	<input type="checkbox"/> TCP4	<input type="checkbox"/> CANSTR
NMEA-GP-RMC_GNSS	<input type="checkbox"/> UART1	<input type="checkbox"/> UART2	<input type="checkbox"/> TCP0	<input type="checkbox"/> TCP1	<input type="checkbox"/> TCP2	<input type="checkbox"/> TCP3	<input type="checkbox"/> TCP4	<input type="checkbox"/> CANSTR
NMEA-GP-RMC_GNSS1	<input type="checkbox"/> UART1	<input type="checkbox"/> UART2	<input type="checkbox"/> TCP0	<input type="checkbox"/> TCP1	<input type="checkbox"/> TCP2	<input type="checkbox"/> TCP3	<input type="checkbox"/> TCP4	<input type="checkbox"/> CANSTR
NMEA-GP-RMC_GNSS2	<input type="checkbox"/> UART1	<input type="checkbox"/> UART2	<input type="checkbox"/> TCP0	<input type="checkbox"/> TCP1	<input type="checkbox"/> TCP2	<input type="checkbox"/> TCP3	<input type="checkbox"/> TCP4	<input type="checkbox"/> CANSTR
NOV_B-BESTGNSSPOS_GNSS1	<input type="checkbox"/> UART1	<input type="checkbox"/> UART2	<input type="checkbox"/> TCP0	<input type="checkbox"/> TCP1	<input type="checkbox"/> TCP2	<input type="checkbox"/> TCP3	<input type="checkbox"/> TCP4	<input type="checkbox"/> CANSTR
NOV_B-BESTGNSSPOS_GNSS2	<input type="checkbox"/> UART1	<input type="checkbox"/> UART2	<input type="checkbox"/> TCP0	<input type="checkbox"/> TCP1	<input type="checkbox"/> TCP2	<input type="checkbox"/> TCP3	<input type="checkbox"/> TCP4	<input type="checkbox"/> CANSTR
NOV_B-HEADING2	<input type="checkbox"/> UART1	<input type="checkbox"/> UART2	<input type="checkbox"/> TCP0	<input type="checkbox"/> TCP1	<input type="checkbox"/> TCP2	<input type="checkbox"/> TCP3	<input type="checkbox"/> TCP4	<input type="checkbox"/> CANSTR
FP_A-GNSSANT	<input type="checkbox"/> UART1	<input type="checkbox"/> UART2	<input type="checkbox"/> TCP0	<input type="checkbox"/> TCP1	<input type="checkbox"/> TCP2	<input type="checkbox"/> TCP3	<input type="checkbox"/> TCP4	<input type="checkbox"/> CANSTR
FP_A-GNSSCORR	<input type="checkbox"/> UART1	<input type="checkbox"/> UART2	<input type="checkbox"/> TCP0	<input type="checkbox"/> TCP1	<input type="checkbox"/> TCP2	<input type="checkbox"/> TCP3	<input type="checkbox"/> TCP4	<input type="checkbox"/> CANSTR

Save and apply
Revert to current
Disable all

Figure 5.18.: Output message configuration

5.4.6. Wheelspeed input options

Vision-RTK 2 offers multiple methods for streaming wheelspeed data. This section provides a detailed overview of the available options.

1. **I/O streaming:** Wheelspeed data can be transmitted through I/O using the CANSTR, UART, or TCP protocols, adhering to the FP_B-MEASUREMENTS format specified by Fixposition (see https://docs.fixposition.com/fd/fp_b-measurements). Users must populate the corresponding payload according to established guidelines.
2. **Fixposition CAN message streaming:** Users can directly transmit the Fixposition-defined CAN message via the CAN interface (see <https://docs.fixposition.com/fd/fixposition-can-frame>). This process is independent of CANSTR, and users do not need to configure CANSTR for this functionality. It is important to note that CANSTR operates at a higher application layer. The distinctions between CANSTR and the CAN interface are elaborated in Section 5.4.3.
3. **ROS speed topic streaming:** A dedicated ROS topic, '/fixposition/speed', can be populated with speed data, adhering to the ROS message format specified at https://github.com/fixposition/fixposition_driver/blob/main/fixposition_driver_ros1/msg/Speed.msg. Upon receiving this data, the ROS network forwards it to the Fixposition driver. The driver then recognizes the data package and delivers the corresponding FP_B-MEASUREMENTS message to the Fusion engine.

Ensuring adequate configurations for seamless data integration and optimal system performance is imperative. The user can input wheelspeed measurements over any port (see Section 5.4) based on the wheelspeed measurement configuration employed (see Section 5.7). The corresponding messages must be input at regular intervals, and the input rate must be at most 50 Hz. The latency (from measuring the wheelspeed to inputting it on the selected port) must be as low as possible. Increased, and in particular, irregular latency degrades the Vision-RTK 2's performance.

5.5. Correction service configuration

The Vision-RTK 2 requires RTCM3 data to provide real-time corrections for accurate localization. The user can configure the correction service in the "Configuration → GNSS" panel of the web interface. The correction service configuration must fulfill the following specifications:

- **Coverage:** The area of operation of the sensor must match the geographic operation area of the correction service provider.
- **Transport:** Networked Transport of RTCM via Internet Protocol (NTRIP), version 1 or 2. This method implies that the sensor must have access to the Internet and the chosen service/server.
- **Data format:** The supported RTCM3 messages are listed in Subsection 5.5.1.
- **Data content:** OSR-style multi-signal messages (MSM).
- **GNSS constellations:** The data must include all four major GNSS constellations (i.e., GPS, GLONASS, Galileo, and BeiDou). Missing systems will degrade performance significantly.

The user must select the desired method to input the correction data in the "Source" parameter (see Figure 5.19 for reference). The following methods are available:

- **NTRIP client (auto):** This is the preferred method. It employs the built-in NTRIP client to connect to a chosen NTRIP caster.
 - This method requires that the sensor has network (Internet) access to the caster server.
 - If the NTRIP caster does not use a login, put dummy or none for the User and Password fields.
- **NTRIP client (v1) or NTRIP client (v2):** This method forces the built-in client to assume an NTRIP caster version 1 or 2, respectively. This option can be helpful when the "auto" option does not work with a particular caster.
- **TCP client:** This method employs a built-in raw TCP/IP client to connect to any host/IP and port to get correction data. For this option, no user, password, or mount-point is needed.
- **I/O port:** This method requires the user to stream the corresponding RTCM3 messages (see Subsection 5.5.1) at the appropriate rates over any of the I/O ports available on the Vision-RTK 2. In this mode, the sensor does not send its location. If the host system requires a position message, the appropriate output message(s) can be configured (typically, NMEA-GP-GGA_NTRIP). In this configuration, the built-in NTRIP client in the Vision-RTK 2 is disabled, and the sensor does not need an Internet connection for the correction data. It is entirely up to the user to correctly provide the correction data on an I/O port. The user can visualize the number of bytes, messages, and errors received through any port in the "I/O status" field in the "System → Info" page. Please refer to Subsection 6.3 for the details.

For the NTRIP and TCP methods, one can choose if and how to send the sensor's location to the caster:

- **Automatic:** Automatically chooses the best available position from the GNSS receivers and the Fusion engine.

- **Manual:** The client sends a user-configured position to the caster. The "Use current" button fills the form with the current position from the GNSS receiver (preferring GNSS1, fall-back to GNSS2).
- **None:** The client sends no position to the caster. Note that most casters, particularly VRS ones, require a position to start streaming correction data.

The "Enter path" button can be used to easily configure a client using a string in one of the following forms:

- **For NTRIP client:** user:pass@host:port/mountpoint
- **For TCP client:** tcpcli://host:port

The Restart client button force-restarts the built-in NTRIP client. Note that the client automatically keeps trying to connect to the configured caster until it succeeds. If the sensor receives no data for 10 seconds, it automatically tries to reconnect.

Notes:

- The GNSS status page can be used to check whether the sensor receives the correction data correctly.
- Any VRS or closest-basestation RTK correction service requires an initial position estimate (single-3D GNSS position) to select or generate the corresponding physical/virtual basestation to be used by the sensor/rover. Thus, the user must head outdoors to establish the connection to the RTK service provider.

The screenshot shows the 'GNSS Configuration' page in the Fixposition web interface. At the top, there is a navigation bar with 'FIXPOSITION' and menu items for 'Status', 'Configuration', and 'System'. A user ID 'fp-6d9e38' is shown in the top right. The main content area is titled 'GNSS Configuration' and contains a 'Correction data' section with a green 'connected' status indicator. The configuration is organized into several rows:

- Source:** A dropdown menu set to 'NTRIP client (auto)' and an 'Enter path' button.
- User:** A text input field containing 'fixposition'.
- Password:** A text input field with masked characters and a toggle icon.
- Host:** A text input field containing 'ntrip.fixposition.com' and a 'Sourcetable' button.
- Port:** A text input field containing '2101'.
- Mountpoint:** A text input field containing 'FP01'.
- Position:** A section with a dropdown menu set to 'Automatic' and a 'Use current' button. Below it are three text input fields for Latitude, Longitude, and Height, all containing '0'. Small text provides examples: 'Latitude in fractional degrees (-90.0...90.0), for example: 47.40020', 'Longitude in fractional degrees (-180.0...180.0), for example: 8.45036', and 'Height in meters (-1'000.0...10'000.0), for example: 395'.

At the bottom of the configuration area, there are three buttons: 'Save and apply' (blue), 'Revert to current' (grey), and 'Restart client' (yellow).

Figure 5.19.: RTK configuration page in the web interface

In addition, you can visualize the NTRIP caster source table by pressing the "Sourcetable button". Here you can find more information regarding the NTRIP caster (e.g., host, port, ID, location), available networks (e.g., ID, operator, web data), and corresponding streams (e.g., mountpoint, format, RTCM3 message types, GNSS constellations).

NTRIP caster sourcetable (ntrip.fixposition.com:2101) 47.400/8.450 x

Casters													
Host	Port	ID	Operator	NMEA	Country	Lat	Lon	Misc					
ntrip.fixposition.com	2101	fixposition	Fixposition AG	0	CHE	47.40	8.45						

Networks									
ID	Operator	Auth	Fee	Web net	Web str	Web reg	Misc		
fixposition	Fixposition AG	B	Y	https://fixposition.com	https://fixposition.com	support@fixposition.com			

Streams															
Mountpoint	ID	Format	Details	Carrier	GNSS	Net	Location	NMEA	Sol	Generator	Compr	Auth	Fee	Rate	Misc
FP01 <input type="button" value="Use"/>		Schlieren 3.3	RTCM 1074(1), 1087(1), 1094(1), 1124(1), 1230(1), 1005(1)	2	GPS+	fixposition	CHE	0	0	Fixposition	none	B	Y	5500	L1/L2
					GLO+					Secret Sauce					
					GAL+			0.0 km							
					BDS										
FP03 <input type="button" value="Use"/>		Schlieren 3.3	RTCM 1074(1), 1084(1), 1094(1), 1124(1), 1008(1)	3	GPS+	fixposition	CHE	0	0	Fixposition	none	B	Y	8500	experimental
					GLO+					Secret Sauce				L1/L2/L5	
					GAL+			0.0 km							
					BDS										

Figure 5.20.: NTRIP caster sourcetable

Note: Many casters do not provide a complete or accurate source table, and some do not provide one at all.

5.5.1. Supported RTCM3 messages

Besides meeting the general requirements for correction service data, the Vision-RTK 2 requires that the latency (age) of the data should be kept as low as possible (ideally better than 1 second) and at least the following RTCM3 messages for proper operation:

Type	Message
Reference station position - Update rate: every 10s or less	One of the following: - RTCM type 1005 (Stationary RTK reference station ARP) - RTCM type 1006 (Stationary RTK reference station ARP with antenna height)
GPS observables - Update rate: 1Hz	One of the following: - RTCM type 1074 (GPS MSM4) - RTCM type 1075 (GPS MSM5) - RTCM type 1077 (GPS MSM7)
Galileo observables - Update rate: 1Hz	One of the following: - RTCM type 1094 (Galileo MSM4) - RTCM type 1095 (Galileo MSM5) - RTCM type 1097 (Galileo MSM7)
BeiDou observables - Update rate: 1Hz	One of the following: - RTCM type 1124 (BeiDou MSM4) - RTCM type 1125 (BeiDou MSM5) - RTCM type 1127 (BeiDou MSM7)
GLONASS observables - Update rate: 1Hz	One of the following: - RTCM type 1084 (GLONASS MSM4) - RTCM type 1085 (GLONASS MSM5) - RTCM type 1087 (GLONASS MSM7)
GLONASS code-phase biases - Update rate: every 5s or less	- RTCM type 1230

Table 5.6.: List of required RTCM3 input messages

5.5.2. RTKLIB/str2str

RTKLIB's str2str application has the capacity to divide an incoming data stream into several streams, each with different formats. Users interested in leveraging this functionality on a host system to connect to the NTRIP service, retrieve RTCM3 data, and subsequently relay this correction information to the Vision-RTK 2 via I/O (UART/TCP), can follow the steps below. These guidelines will cover RTKLIB installation, establishing a connection with the NTRIP service, and streaming data to a designated IP address and port.

1. Update the system packages:

```
sudo apt-get update
```

2. Install necessary tools for building RTKLIB:

```
sudo apt-get install build-essential gcc g++ git
```

3. Clone the RTKLIB repository:

```
git clone git@github.com:rinex20/RTKLIB-demo5.git
```

4. Navigate to the RTKLIB build directory:

```
cd RTKLIB-demo5/app/consapp/str2str/gcc
```

5. Compile RTKLIB:

```
make
```

This process will generate an executable named *str2str* in the RTKLIB build directory.

Within the Vision-RTK 2 web interface, users can navigate to "Configuration → GNSS", then select the "I/O port" option. This will enable users to stream RTCM3 data to any accessible TCP/UART port on the Vision-RTK 2 device.

Some NTRIP services (including certain VRS services) require receivers to reciprocate with NMEA-GP-GGA_GNSS data. This enables the service provider to assign the user a nearby real or virtual base station. Given these circumstances, users also need to configure Vision-RTK 2 to output the NMEA-GP-GGA_GNSS data. For instance, a TCP port (like TCP4) can be set to exclusively output NMEA-GP-GGA_GNSS data at a rate of 10 or less, as depicted in Figure 5.21.

GNSS data ⓘ	UART1	UART2	TCP0	TCP1	TCP2	TCP3	TCP4	CANSTR
NMEA-GP-GGA_GNSS	0	0	0	0	0	0	10	0

Figure 5.21.: The set up of the output of NMEA-GP-GGA_GNSS in the I/O section

To establish a connection with the NTRIP service and stream data to a preferred IP address and port, the following command can be implemented:

```
str2str -in ntrip://<username>:<password>@<ntrip\_service\_url>:<port>
>/<mountpoint> -out tcpcli://<IP\_address>:<port> -b 1
```

In this command:

- Replace **<username>:<password>** with your NTRIP service username and password.
- Replace **<ntrip_service_url>:<port>/<mountpoint>** with the URL, port, and mountpoint for your NTRIP service.
- The **tcpcli://<IP_address>:<port>** argument instructs *str2str* to output the RTCM data as a TCP server at the specified IP address and port.

This command initiates data streaming. To halt the stream, press Ctrl+C in the terminal running *str2str*. Depending on your requirements, these steps may need adjustments. For instance, if you desire the stream to initiate automatically at system startup, consider creating a systemd service.

Note: The *str2str* utility has the capability to multiplex a single RTK correction source to multiple clients. The correction source can be either a serial port, a raw TCP/IP connection, or an NTRIP client. The *str2str* caster is designed to handle multiple clients efficiently. However, it is important to note that a VRS-type correction source is only compatible with this version here: <https://github.com/rinex20/RTKLIB-demo5>. Other forks or the *str2str* installed from Ubuntu's apt-get might not work with VRS correction.

For additional information, refer to https://rtkexplorer.com/pdfs/manual_demo5.pdf.

5.6. Camera configuration

The user can visualize the camera stream in the "Configuration → Camera" page of the web interface. A distorted and downsampled (both in resolution and frame rate) stream of the camera is presented here. As Chapter 4.1 mentions, no static parts or featureless scenes must be present in the image view, as these would affect the sensor's performance. The user can use the cropping tools to eliminate these featureless areas.

The screenshot displays the 'Camera Configuration' page in the Fixposition web interface. At the top, the navigation bar includes 'FIXPOSITION', 'Status', 'Configuration', and 'System'. The page title is 'Camera Configuration'. The main content area is titled 'Camera image' and features a live video stream of a road scene. Below the stream is a 'Refresh live stream' button. The configuration section is divided into several fields: 'Image cutout' with 'Top %' and 'Bottom %' input boxes (both set to 0); 'Stream' with 'Enable stream' (set to 'Disable'), 'Encoding' (set to 'H.264 (compressed)'), 'Destination' (set to '224.0.10.1:5004'), and 'Method' (set to 'Multicast'). At the bottom of the configuration section are 'Save and apply' and 'Revert to current' buttons. A 'Camera calibration' section is partially visible at the bottom of the page.

Figure 5.22.: Camera configuration page in the web interface

Note: The auto-exposure calibration of the camera is affected by the cropped area. Thus, cropping this section will help with exposure if there is a bright object at all times in the camera view. Figure 5.23 presents an example of how to crop these undesired features from the camera view.

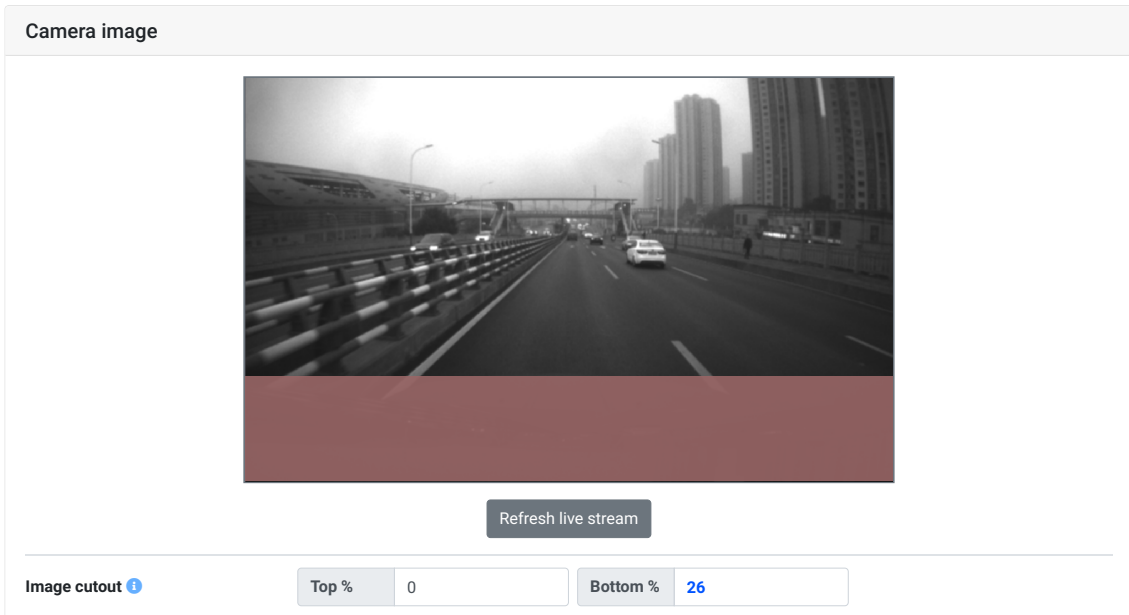

Figure 5.23.: An example of the image view's cutout

5.6.1. Camera streaming

The camera image streaming implementation on the Vision-RTK 2 employs the Real-time Transport Protocol (RTP), which is a well-established network protocol for delivering video over IP networks. It runs over the User Datagram Protocol (UDP). RTP is designed for end-to-end, real-time transfer of streaming media. The protocol provides facilities for jitter compensation and detection of packet loss and out-of-order delivery, which are common, especially during UDP transmissions on an IP network. RTP allows data transfer to multiple destinations through IP multicast.

The camera stream is not enabled by default. To enable it, head to the "Configuration → Camera" page and change the "Enable stream" status. Two different encodings can be selected in the Encoding setting: H264 or H265. Depending on the streaming method used, different UDP destinations can be chosen: Multicast or Unicast.

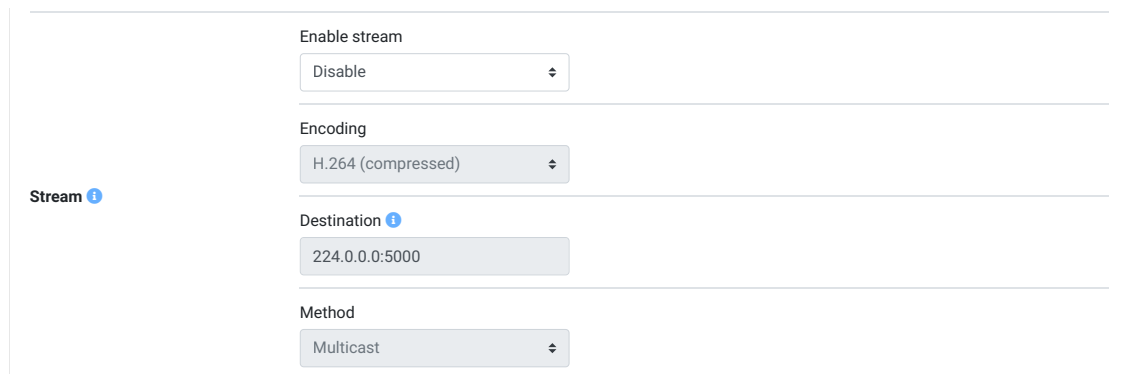

Figure 5.24.: Camera stream configuration

Some notes and warnings:

- For the best performance, the images should always be streamed via Ethernet. Image interference commonly occurs during transmission over WLAN.
- The streamed images are compressed to reduce CPU load.
- The receiver must be capable of RTP as well as understand the selected encoding.
- The camera's intrinsic data is available to users upon request. The reference camera model is based on the OpenCV documentation **OpenCV Fish-eye Camera Calibration** https://docs.opencv.org/3.4/db/d58/group__calib3d__fisheye.html#details.

For examples on how to enable and read the camera stream, please refer to <https://docs.fixposition.com/fd/camera-image-streaming>.

5.7. Wheelspeed sensor configuration

The user can configure the wheelspeed sensor input by accessing the "Configuration → Wheelspeed" panel of the web interface. The wheelspeed sensor can be connected to any of the UART, TCP, or CAN ports. However, before setting up the wheelspeed sensor, the corresponding ports should be configured according to Section 5.4.

The screenshot shows the 'Wheelspeed Configuration' web interface. It features a dark header with the 'FIXPOSITION' logo and navigation menus for 'Status', 'Configuration', and 'System'. The main content area is titled 'Wheelspeed Configuration' and contains two sections: 'Sensors configuration' and 'General configuration'. The 'Sensors configuration' section has a 'Presets' dropdown and a table with five rows for Sensor 1 through Sensor 5. Each row has an 'Enable' checkbox (all checked) and a dropdown menu set to 'Disabled'. The 'General configuration' section has two rows: 'Wheelspeed sign' set to 'Signed' and 'Record raw CAN' set to 'Disabled'. At the bottom are 'Save and apply' and 'Revert to current' buttons.

Figure 5.25.: Wheelspeed sensor configuration on the web interface

The wheelspeed configuration supports up to five external sensors (up to ten by enabling the advanced features). Each sensor requires a specific definition to be an input to the sensor fusion engine. The user should use one of our presets to configure the sensor (see Figure 5.26). The order of the wheelspeed sensor definition does not matter. The low-level sensor configuration required by any of the ports involves the following fields:

- **Enable** – Enables the wheelspeed sensor. If unchecked, the Vision-RTK 2 will not use any other parameters. It can be left unchecked to keep the configuration saved.
- **Name** – Reference name for the wheelspeed sensor representing the type of measurement that it will generate. The value must be unique among all enabled sensors. Depending on the setup, it should be one of the following:
 - RC (rear centre) – Rear Centre wheel (Most common case). It refers to a velocity in the same rigid body as the sensor.
 - RL (rear left) – Rear Left wheel.
 - RR (rear right) – Rear Right wheel.
 - FL (front left) – Front Left wheel.
 - FR (front right) – Front Right wheel.
- **Type** - Unique identifier that specifies how to read this particular sensor type.

- **Reverse** – When enabled, the low-level driver inverts the sign of the measurement.
- **Use sensor** – When enabled, the Fusion engine uses this sensor’s measurements.
- **Translation** – Translation from the center of the Vision-RTK 2’s frame to the center of the wheelspeed sensor axis, expressed in the Vision-RTK 2’s frame in meters (see Figure 3.6 for reference).
- **Rotation** – Euler angle rotation to move the unit vectors from the Vision-RTK 2’s frame to the wheelspeed frame in degrees.
- **Dimension** – Enable wheelspeed measurements in the given axis.

The general configuration shared by all sensors includes the following fields:

- **Wheelspeed sign** – Indicates if the wheelspeed values are signed (i.e., negative for backward movement and positive for forward). If unchecked, the Fusion engine interprets only the magnitude of the wheelspeed values and considers the unknown direction of motion. Keep this setting unchecked when mixing sensors with signed and unsigned values. We advise enabling the ‘wheelspeed sign’ option if supported by the wheel odometry sensor, as it causes the Vision-RTK 2 to react faster to wheelspeed measurements after being stationary.
- **Record raw CAN** – When enabled, the sensor records the CAN frames in the bus. Only use when advised, as this option will impact performance.

The screenshot shows the 'Wheelspeed Configuration' interface. At the top, there's a navigation bar with 'FIXPOSITION' and menu items 'Status', 'Configuration', and 'System'. The user ID 'fp-6d9e38' is visible. Below the navigation bar, the title 'Wheelspeed Configuration' is displayed. The main content area is titled 'Wheelspeed sensors' and is divided into two sections: 'Sensors configuration' and 'General configuration'. In the 'Sensors configuration' section, there are five rows for 'Sensor 1' through 'Sensor 5'. Each row has an 'Enable' toggle (all are 'Enable'), an information icon, and a dropdown menu (all are 'Disabled'). The 'General configuration' section has two rows: 'Wheelspeed sign' (set to 'Signed') and 'Record raw CAN' (set to 'Disabled'). At the bottom left, there are two buttons: 'Save and apply' and 'Revert to current'. On the right side, a list of preset configurations is shown, including 'Fixposition I/O message (vehicle speed, I/O port)', 'Fixposition I/O message (two wheels, I/O port)', 'Fixposition I/O message (four wheels, I/O port)', 'Fixposition CAN message (vehicle speed, CAN)', 'Fixposition CAN message (two wheels, CAN)', 'Fixposition CAN message (four wheels, CAN)', 'Agilex Bunker (CAN)', 'Agilex Scout (CAN)', 'ArchDrive e-car (CAN)', 'ArchDrive small robot (CAN)', 'DFCVT (CAN)', 'Falcon (CAN)', 'Kyburz DX bike (CAN)', 'Neolix (CAN)', 'PIX Moving (CAN)', and 'Renault (CAN)'.

Figure 5.26.: Preset list of the CAN and I/O wheelspeed configurations

5.7.1. Fixposition CAN wheelspeed sensor

The CAN message must be formatted as described in <https://docs.fixposition.com/fd/fixposition-can-frame> for a generic speed input. The user should send the corresponding CAN frames at regular intervals, where the input rate must be at most 50 Hz. The message latency, measured from computing the wheelspeed to broadcasting it over the CAN bus, must be as low as possible. Increased and, in particular, irregular latency degrades the Vision-RTK 2's performance. The low-level sensor parameters are automatically filled in when one of the preset settings is selected. For example, Figure 5.27 presents the configuration when the "Fixposition CAN message (vehicle speed, CAN)" preset is selected.

Wheelspeed Configuration

Sensors configuration Presets ▾

Sensor	Enable ⓘ	Name (wheel) ⓘ	Type ⓘ	Reverse ⓘ	Use sensor ⓘ	Translation ⓘ	Rotation ⓘ	Dimensions ⓘ
Sensor 1	Enabled ▾	RC (rear centre) ▾	Fixposition CAN ▾	Disabled ▾	Enabled ▾	x y z 	yaw (z) 0.00 pitch (y) 0.00 roll (x) 0.00	x Enabled ▾ y Disabled ▾ z Disabled ▾
Sensor 2	Disabled ▾							
Sensor 3	Disabled ▾							
Sensor 4	Disabled ▾							
Sensor 5	Disabled ▾							

General configuration

Wheelspeed sign ⓘ Signed ▾

Record raw CAN ⓘ Disabled ▾

CAN bus sensors configured. Please make sure that the CAN interface is configured appropriately on the [I/O Configuration](#) page.

Save and apply Revert to current

Figure 5.27.: Fixposition CAN message (vehicle speed) preset configuration

Based on the Fixposition CAN frame structure, when the Rear Centre (RC) wheelspeed sensor is selected, the corresponding vehicle wheelspeed value will be written in the Front Right (FR) data field. Thus, the Fixposition CAN message will be structured as follows:

- FR: vehicle speed value [mm/s]
- FL: 0xffff
- RR: 0xffff
- RL: 0xffff

Else, if two or more wheelspeed sensors are selected, the message structure will be:

- FR: vehicle speed value [mm/s]
- FL: vehicle speed value [mm/s]
- RR: vehicle speed value [mm/s]
- RL: vehicle speed value [mm/s]

The Fixposition CAN message can support wheelspeed measurements from one or four wheels. However, if two or more wheels are used, the user can combine their vectors and input them as a single rear center measurement. For customizing the Fixposition CAN message interface of the Vision-RTK 2, please consult the Fixposition team.

5.7.2. Verifying Fixposition CAN message configuration

For proper operation using the Fixposition CAN message, the user must verify the following four components:

1. A host machine equipped with a CAN interface should transmit the CAN messages per the specifications of the Fixposition CAN frame detailed in <https://docs.fixposition.com/fd/fixposition-can-frame>. The Fixposition message adheres to the Classic CAN protocol with CAN ID 0x146. For a single speed input, populate bytes 0-1 with RC. For multiple wheelspeed inputs, assign the payload as follows: FR for bytes 0-1, FL for bytes 2-3, RR for bytes 4-5, and RL for bytes 6-7.
2. Wheelspeed settings in the web interface must align with the composition of the CAN message. For instance, if the user transmits data for four wheelspeed measurements, the user must configure all four data sources in the web interface. Conversely, if only two wheelspeeds (e.g., RR and RL) are used, FR and FL should be left blank in the CAN message. In the web interface, disable sensors 1 and 2 and set sensors 3 and 4 to RR and RL, respectively.
3. Activate the CAN interface on the Vision-RTK 2 system. It is crucial to ensure that the bitrate matches that of the host machine, facilitating seamless communication among all devices on the CAN bus.
4. Note that for this configuration to work, the CAN bus must be connected to CANL (CAN low), CANH (CAN high), and GND (Ground) in the I/O connector.

5.7.3. Fixposition I/O wheelspeed sensor

For streaming the wheelspeed values via the UART or TCP ports, the user must employ the FP_B-MEASUREMENTS message detailed in https://docs.fixposition.com/fd/fp_b-measurements. The binary message must be input on a UART/TCP port at a regular interval with a maximum rate of 50 Hz. The message latency, measured from computing the wheelspeed to broadcasting it over the I/O port, must be as low as possible. The low-level sensor parameters are automatically filled in when one of the preset settings is selected. For example, Figure 5.28 presents the configuration when the "Fixposition I/O message (vehicle speed, I/O port)" preset is selected.

The screenshot shows the 'Wheelspeed Configuration' interface. At the top, there's a navigation bar with 'FIXPOSITION', 'Status', 'Configuration', and 'System' menus, and a user ID 'fp-6d9e38'. The main title is 'Wheelspeed Configuration'. Below it, there's a 'Presets' dropdown menu. The 'Sensors configuration' section lists five sensors. Sensor 1 is the active one, with the following settings: Enabled, Name (wheel) 'RC (rear centre)', Type 'Fixposition I/O', Reverse 'Disabled', Use sensor 'Enabled', Translation (x, y, z) all set to 0.00, Rotation (yaw (z), pitch (y), roll (x)) all set to 0.00, and Dimensions (x: Enabled, y: Disabled, z: Disabled). Sensors 2, 3, 4, and 5 are all disabled. The 'General configuration' section has 'Wheelspeed sign' set to 'Signed' and 'Record raw CAN' set to 'Disabled'. At the bottom, there are 'Save and apply' and 'Revert to current' buttons.

Figure 5.28.: Fixposition I/O message (vehicle speed, I/O port) preset configuration

If your system employs ROS1 or ROS2, you can use our Fixposition ROS Driver to stream the wheelspeed measurements (https://github.com/fixposition/fixposition_driver).

Note: If you have a ROS topic available with the wheelspeed information, you can use our "Fixposition Odometry Converter" node, which you can find in https://github.com/fixposition/fixposition_driver/tree/main/fixposition_odometry_converter. Currently, messages of the type "geometry_msgs/Twist", "geometry_msgs/TwistWithCov", and "nav_msgs/Odometry" are supported.

5.8. Sensor fusion configuration

The user can configure the sensor fusion engine by accessing the web interface and navigating to the "Configuration → Fusion" panel. In this section, the following configuration options are available:

- **Autostart:** Once enabled, the Fusion engine will be launched automatically on system bootup. Note: Enabling this will not start the Fusion engine directly.
- **Housing:** Prototype (i.e., 3D-printed) or Standard (i.e., aluminum).
- **Tuning mode:** Expected platform dynamics (see Section 2.3).
- **GNSS extrinsics:** Position of the GNSS antennas with respect to the Vision-RTK 2 sensor frame in meters. These values should be accurate to the mm level.

The screenshot shows the Fixposition web interface for Fusion Configuration. The top navigation bar includes the Fixposition logo, menu items for Status, Configuration, and System, and a user ID 'fp-6d9e38' with status indicators. The main heading is 'Fusion Configuration'. The 'Settings' section contains several configuration options:

- Autostart:** A dropdown menu set to 'Enabled'.
- Housing:** A dropdown menu set to 'Standard'.
- Tuning mode:** A dropdown menu set to 'Generic'.
- Preset:** A dropdown menu set to 'Standard starter kit'.
- GNSS extrinsics:** A section with two antenna configurations:
 - Antenna GNSS1:** x: 0.0200, y: -0.1750, z: -0.0200
 - Antenna GNSS2:** x: 0.0200, y: 0.1750, z: -0.0200

At the bottom, there are two buttons: 'Save and apply' (in blue) and 'Revert to current' (in grey).

Figure 5.29.: Fusion engine configuration on the web interface

5.9. Log sensor data

The user can access the web interface and navigate to the "System → Logs" panel to generate a recording of the sensor. The user must press the "Record" button in the "Record logs" module to start recording. To stop a recording, press the "Stop" button.

The user can then extract the performed trajectory using our available tools or upload it to the User Dashboard to visualize the trajectory, employ our analysis tools, and download the corresponding KML data. Fixposition suggests users record over **one minute** of data and starting/finishing under RTK-fixed conditions for a thorough analysis. While users have exclusive access to their data, Fixposition will access it only with explicit user permission. Users can only see/use/delete their data and download the related KML data. If the user wants to use this service, please contact the Fixposition team.

The recording can be performed at the following three locations (targets):

- Internal disk built into the sensor
- External disk connected to USB. This method is not recommended as it can degrade sensor performance.
- Download the log file in real-time using standard HTTP over Ethernet. This method is preferred but needs a stable and reliable Ethernet connection and a client (e.g., web browser, curl).

Note: Recording consumes CPU resources, especially when recording to an external disk, which can result in performance degradation. Use this feature with care.

For more information regarding the recording feature and examples, please refer to <https://docs.fixposition.com/fd/sensor-recording>.

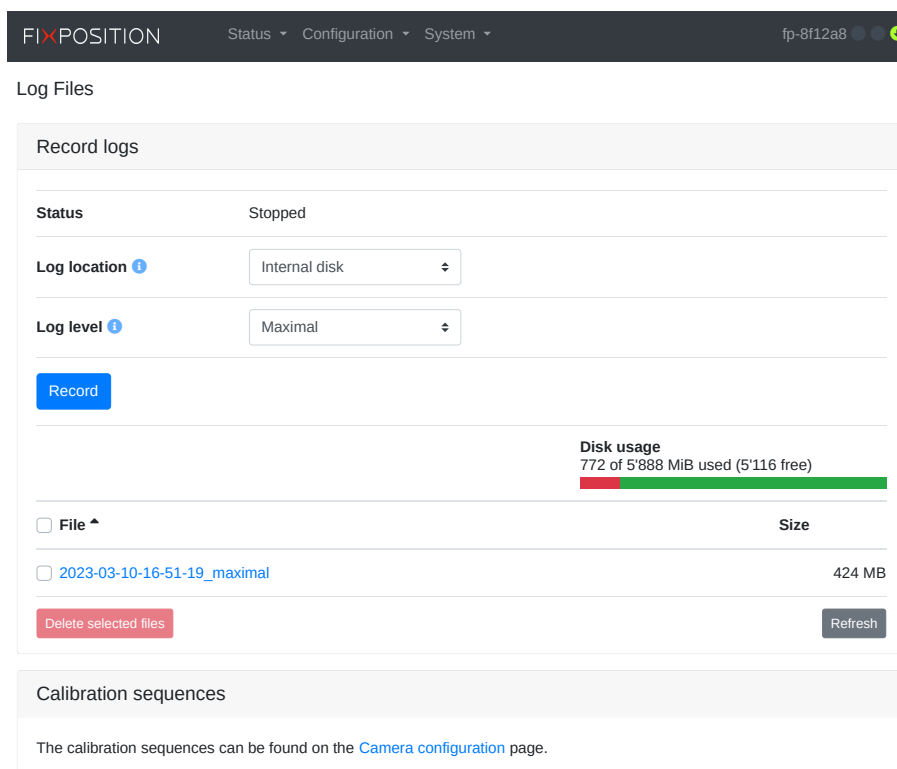

Figure 5.30.: Record data panel on the web interface

5.10. IMU calibration

The Vision-RTK 2 requires a start-up procedure before being fully operational. The user must ensure the following requirements are fulfilled to start the calibration procedure:

- Both receivers have an RTK-fixed status.

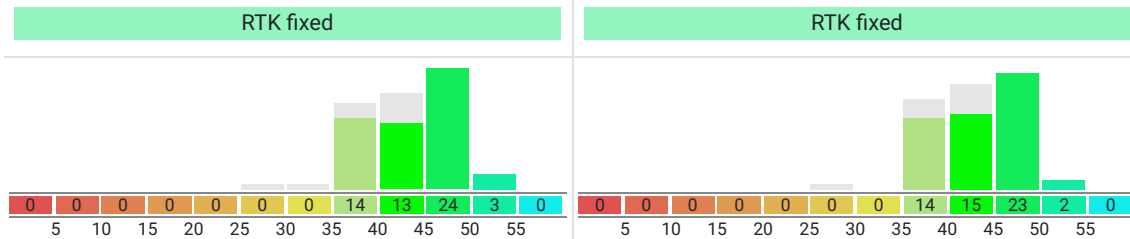

Figure 5.31.: GNSS status view

- The Fusion engine is initialized, and the extrinsics are correct.



Figure 5.32.: Fusion status view

Once fulfilled, drive approximately 2 minutes under RTK-fixed with some dynamic movement to converge the IMU biases. Perform eight figures and move back-and-forth within a 10 meters area as shown in Figure 5.34. The gyroscope and accelerometer bias will converge to steady values with this procedure. The sensor will raise a flag once it is fully calibrated (see field #22 in the FP A-ODOMETRY message).

On the web interface, the user can visualize the status of the calibration procedure and the IMU noise by heading to the "Status → Fusion" page. The corresponding indicators are presented in Figure 5.33. The **IMU status** can be either **Unknown** (sensor not initialized), **Not converged**, or **Converged**. Similarly, the **IMU noise** indicators can be either **Unknown**, **Low noise**, **Medium noise**, or **Excessive noise**. Keep in mind that this indicator is calculated based on the variance of the IMU measurements over a period of time. Some platforms might experience excessive IMU noise without a significant impact on performance. This indicator only informs the user of their system dynamics.

IMU status	Unknown	Not converged	Converged	
IMU noise	Unknown	Excessive noise	Medium noise	Low noise

Figure 5.33.: IMU bias estimation and signal quality indicators

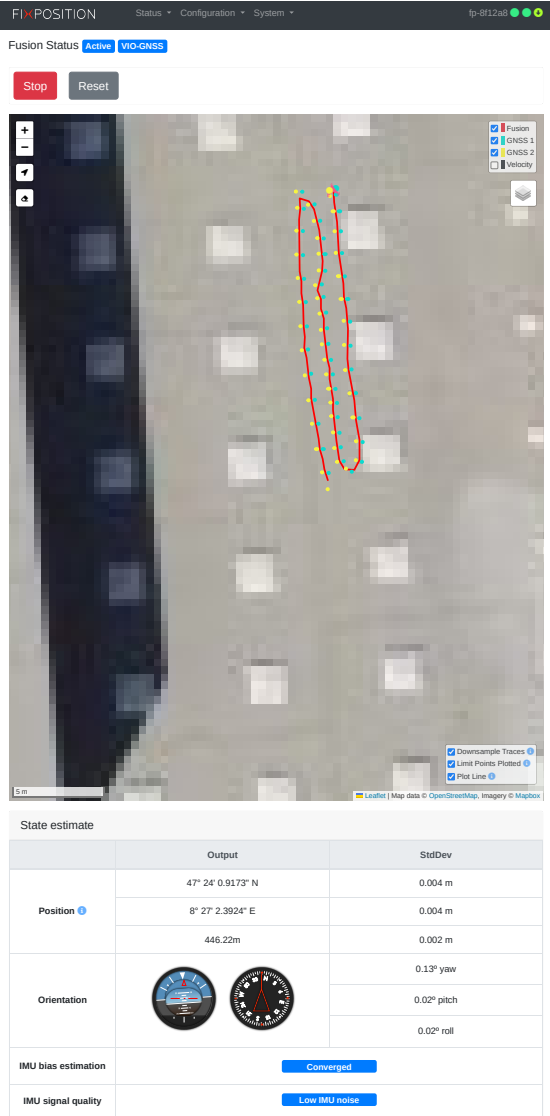

(a) Drive backward and forwards

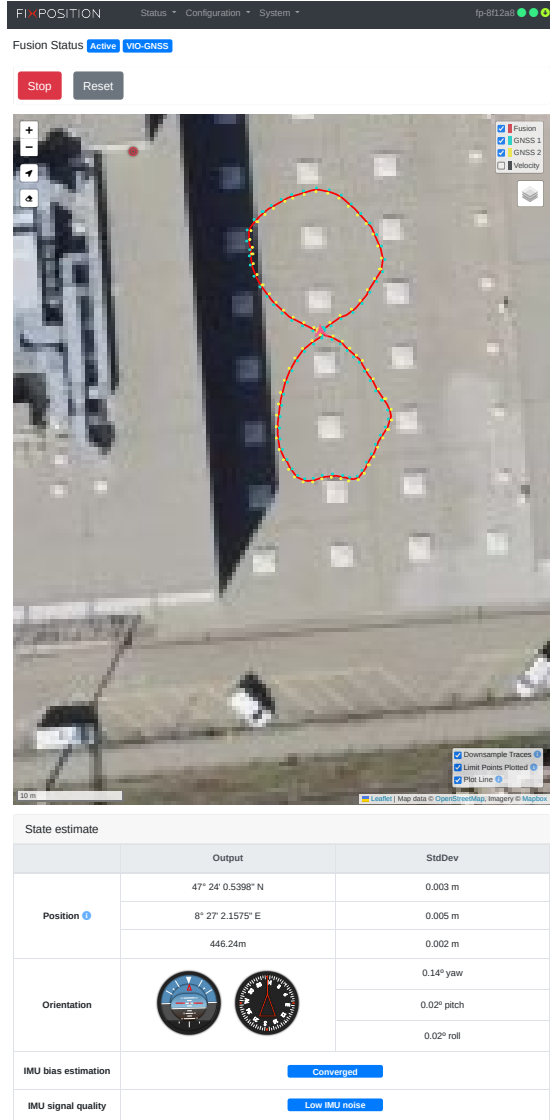

(b) Drive eight figures

Figure 5.34.: Example trajectory for the IMU calibration procedure

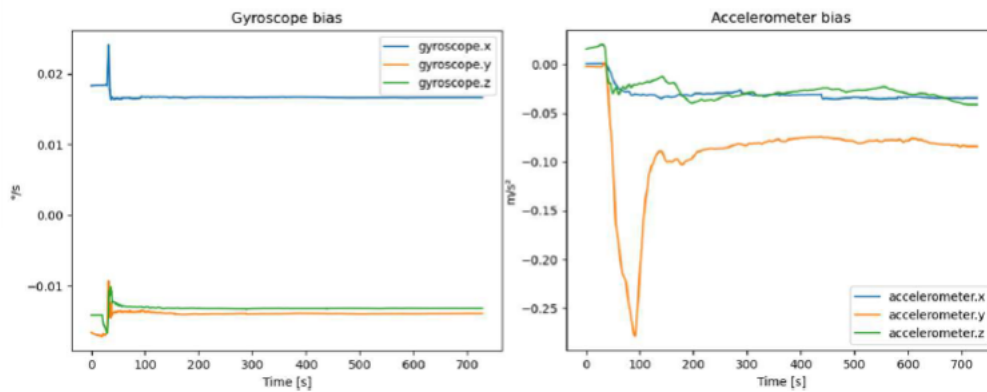

Figure 5.35.: Gyroscope and accelerometer biases over time

5.11. ROS driver installation

Please visit https://github.com/fixposition/fixposition_driver for more information. Since software version 2.63, both ROS1 and ROS2 are supported. The ROS driver version should be compatible with its corresponding software release version.

The Fixposition ROS driver operating as a ROS node can listen to any I/O port to get outputs from the Vision-RTK 2 and then publish them in the ROS network. The user can directly stream the wheelspeed information via CANSTR/TCP/UART into the Vision-RTK 2. They can also fill in the XYZ velocity information from any resources into a ROS message and then publish it inside the ROS network so that the Fixposition ROS driver can subscribe to this information and convert it to FP_B-MEASUREMENTS (binary data).

Finally, this binary information will be streamed into the Fusion engine to improve localization performance. An extra node called Fixposition Odometry Converter is provided to help integrate the wheelspeed on your vehicle. This node is intended to be used as middleware if you already have a topic with the wheelspeed values running on your system. Currently, messages of the type Twist, TwistWithCov and Odometry are accepted.

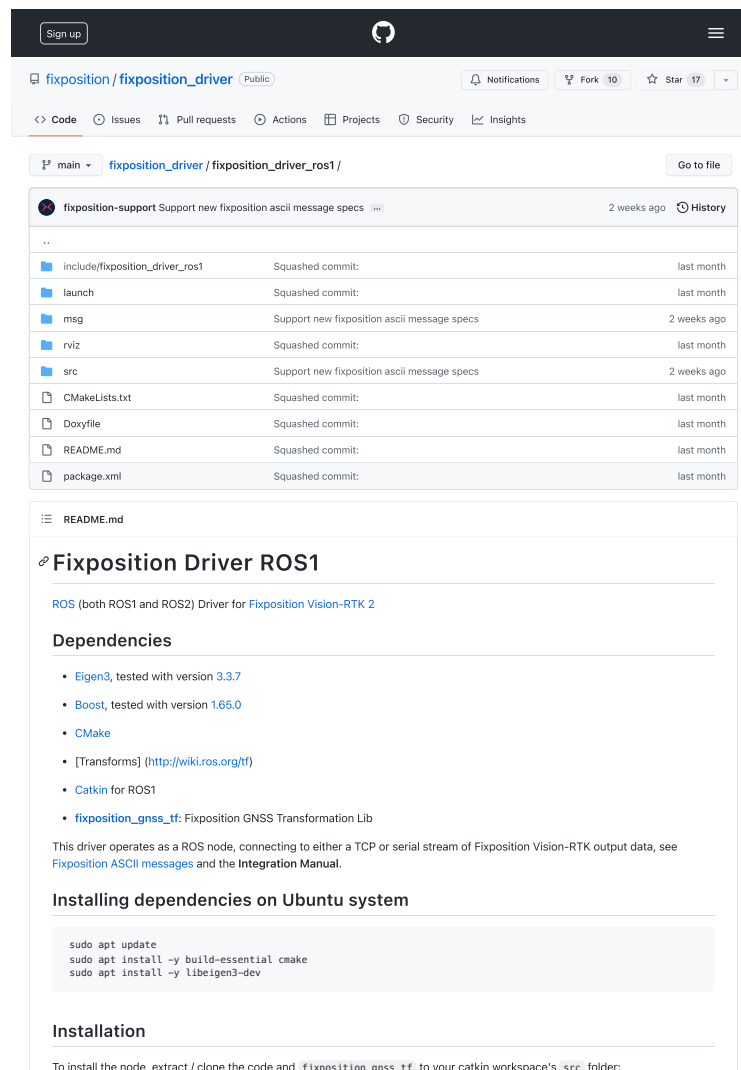

The screenshot shows the GitHub repository page for `fixposition/fixposition_driver`. The repository is public and has 10 forks and 17 stars. The current branch is `main`, and the selected file is `fixposition_driver/fixposition_driver_ros1/`. The repository contains several files and folders, including `include/fixposition_driver_ros1`, `launch`, `msg`, `rviz`, `src`, `CMakeLists.txt`, `Doxyfile`, `README.md`, and `package.xml`. The `README.md` file is selected, showing the following content:

Fixposition Driver ROS1

ROS (both ROS1 and ROS2) Driver for [Fixposition Vision-RTK 2](#)

Dependencies

- [Eigen3](#), tested with version 3.3.7
- [Boost](#), tested with version 1.65.0
- [CMake](#)
- [Transforms] (<http://wiki.ros.org/tf>)
- Catkin for ROS1
- [fixposition_gnss_tf](#): Fixposition GNSS Transformation Lib

This driver operates as a ROS node, connecting to either a TCP or serial stream of Fixposition Vision-RTK output data, see [Fixposition ASCII messages](#) and the [Integration Manual](#).

Installing dependencies on Ubuntu system

```
sudo apt update
sudo apt install -y build-essential cmake
sudo apt install -y libeigen3-dev
```

Installation

To install the node, extract / clone the code and [fixposition_gnss_tf](#) to your catkin workspace's `src` folder:

Figure 5.36.: ROS driver of Vision-RTK 2 from Fixposition in Github

5.12. Point of interest configuration

The default reference frame of the Vision-RTK 2 is located at the X shape on the sensor housing (see section 2.3). If the user requires the odometry output in a different reference frame, the "**Output translation**" meaning "Translation from the sensor to output represented by x-y-z Cartesian coordinates" and "**Output rotation**" meaning "Rotation from the sensor to output represented by Yaw-Pitch-Roll (YPR) in the Cartesian coordinates" fields in the "Output generators" module of the web interface can be used (see Figure 5.16).

The XYZ displacements from the center of the Vision-RTK 2's reference frame to the desired point are expressed in meters. In contrast, the rotation from the sensor's frame to the output's body frame is expressed in degrees using Yaw-Pitch-Roll (YPR) rotations, also known as Euler Angles. For reference, the arrow on the web interface's map page points towards the output frame's positive X direction (see Figure 5.38).

For reference, Figure 5.37 shows an example of a transformation between the VRTK's body frame and the output's body frame using the previously described convention. In this example, the point of interest (POI) is located at an arbitrary point inside the vehicle. Therefore, the user must calculate the XYZ translations from the sensor's frame of reference to the POI and then perform intrinsic rotations using YPR angles.

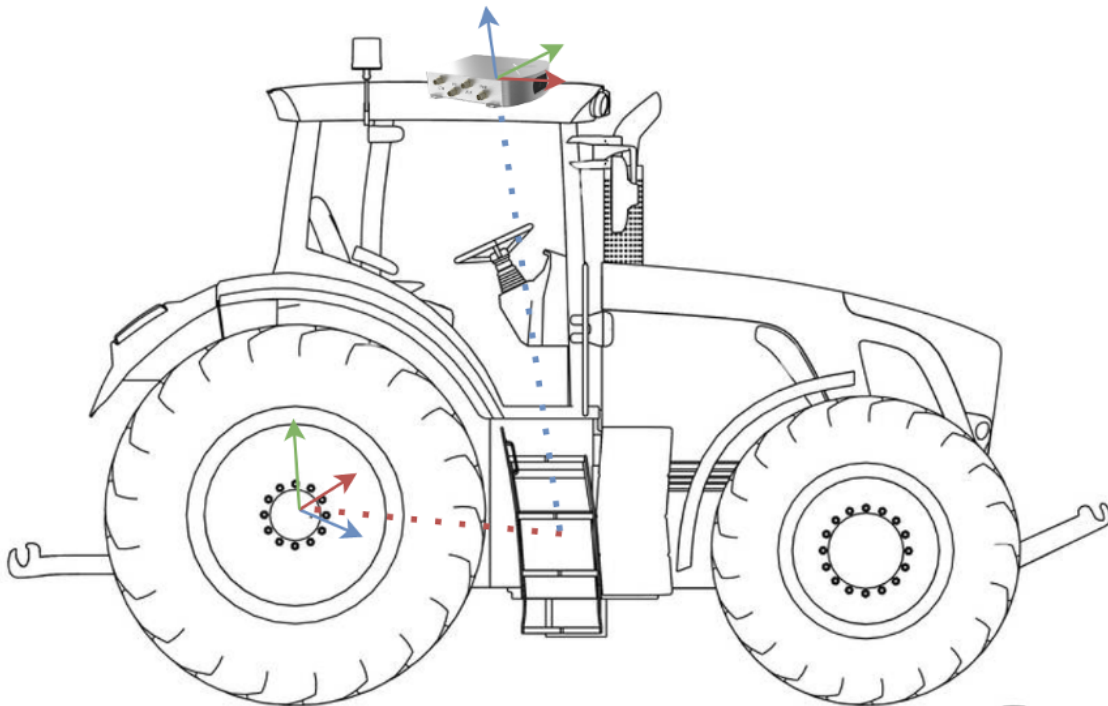

Figure 5.37.: Transform from the Vision-RTK 2's body to the output reference frame

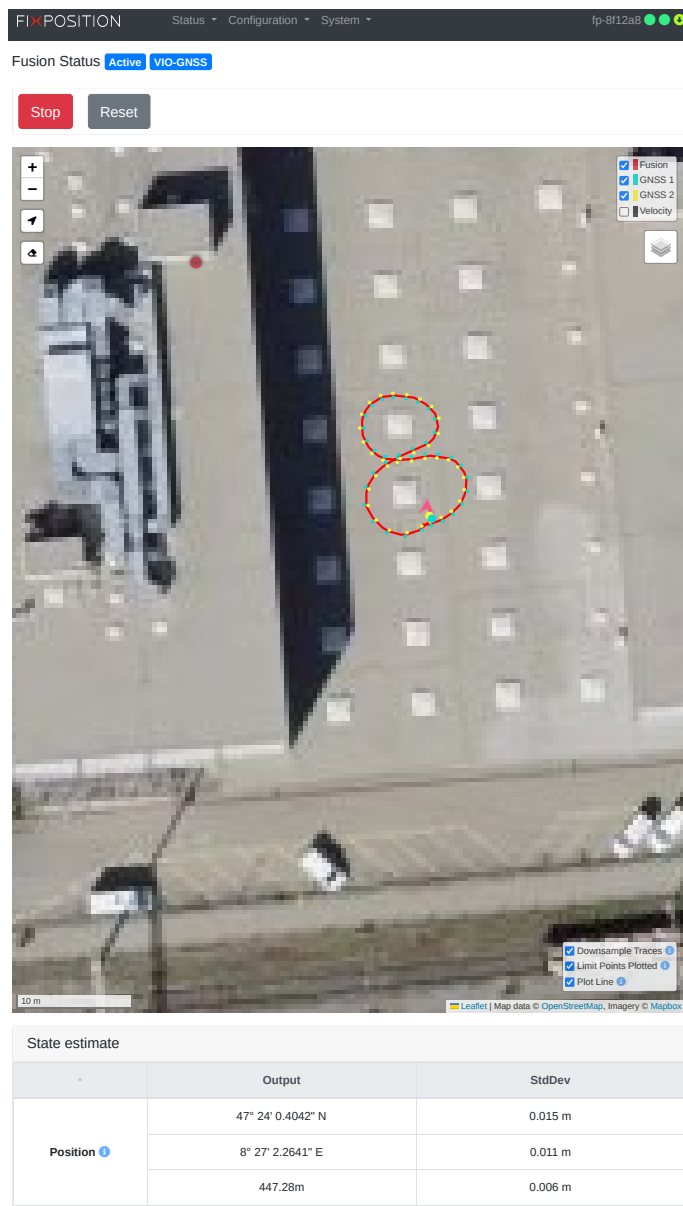

Figure 5.38.: Arrow pointing towards the positive X direction of the output's body frame

5.13. Web interface indicators

The navigation bar of the web interface contains useful indicators to signal the status of the Vision-RTK 2 and its related processes. Figure 5.39 presents all the available indicators.

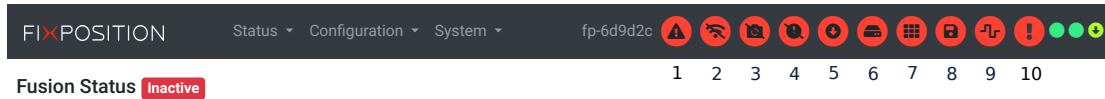

Figure 5.39.: Indicators on the web interface

The available indicators are:

1. **System:** This indicator can arise when the system state is not "running," e.g., during boot-up, shut-down, or when a component fails to initialize.
2. **Internet:** The system is not online. This indicator will appear if the sensor cannot ping the 8.8.8.8 address.
3. **Camera:** Missing camera calibration or failure during camera initialization.
4. **Time synchronization:** The system time is not synchronized with GNSS or NTP time info resources.
5. **Correction data stream:** The sensor is not receiving RTCM3 data. The tooltip will show details (e.g., "warning, connected but no data").
6. **External disk connected:** An external hard disk is connected to the sensor. Note that the user still needs to mount/unmount the disk in "System → Logs" manually.
7. **Recording calibration:** A calibration sequence is being recorded.
8. **Recording log:** A log file is being recorded.
9. **IO stream:** One or more error counters are increasing (I/O of any port). Additionally, a more detailed alert is shown on the I/O status tab of the "System → Info" page (see Figure 5.40). The alert stays visible as long as the error counter(s) keep incrementing and will disappear after a timeout (5s for the indicator, 30s for the alert in the I/O status page). Typical error sources include:

UART ports:

- a) Too many output messages are configured for the selected bandwidth (determined by the baud rate).
- b) Too long, faulty, and/or low-quality cables.
- c) Occasional errors on a UART connection are expected, albeit rare.

CANSTR port:

- a) Too many output messages are configured for the selected bandwidth (determined by the bitrate and other devices on the bus).
- b) Bad CAN termination (missing when required, present when not).
- c) Too long CAN cable (e.g., for OBD2, it must be shorter than 30 cm).
- d) A misbehaving device on the CAN bus.
- e) Too much load on the CAN bus.

- f) Occasional errors on a CAN connection are expected. The frequency depends on various factors (e.g., number of devices, bitrate, cable length).

TCP ports:

- a) Congested network and/or too little bandwidth available. Recommended: use direct one-on-one Ethernet connections between the sensor and host.

Note that on the initial load of the web interface, this warning might appear if the error counters are not zero, even if the last error was a long time ago.

10. **Other:** Unspecified warning - reserved for future use.

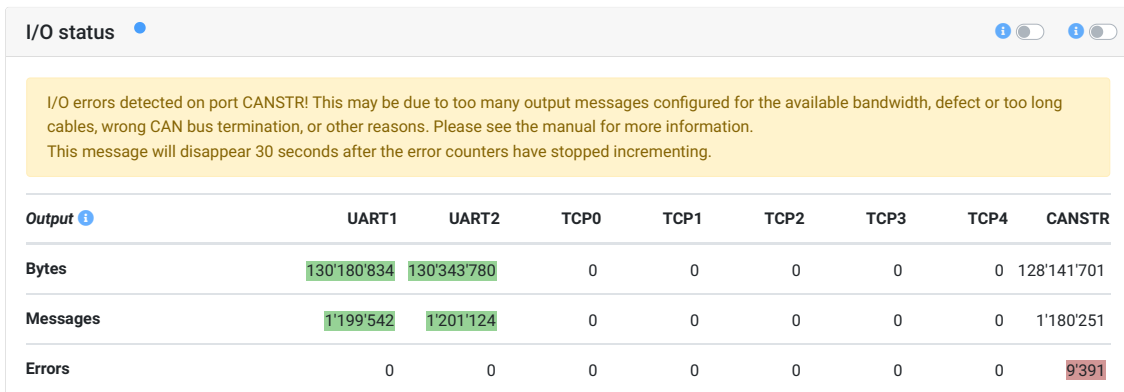

I/O status

I/O errors detected on port CANSTR! This may be due to too many output messages configured for the available bandwidth, defect or too long cables, wrong CAN bus termination, or other reasons. Please see the manual for more information.
This message will disappear 30 seconds after the error counters have stopped incrementing.

Output	UART1	UART2	TCP0	TCP1	TCP2	TCP3	TCP4	CANSTR
Bytes	130'180'834	130'343'780	0	0	0	0	0	128'141'701
Messages	1'199'542	1'201'124	0	0	0	0	0	1'180'251
Errors	0	0	0	0	0	0	0	9'391

Figure 5.40.: Error message on the I/O status tab of the web interface

Additionally, when the GNSS baseline check fails, the following warning appears on the web interface. This indicator does not necessarily suggest an error, as leaving the sensor on a prolonged GNSS outage can trigger this warning due to the low quality of the RTK correction data. Nonetheless, the user should verify their GNSS extrinsics if this error often appears under good GNSS conditions or RTK-fixed at the mission's beginning.

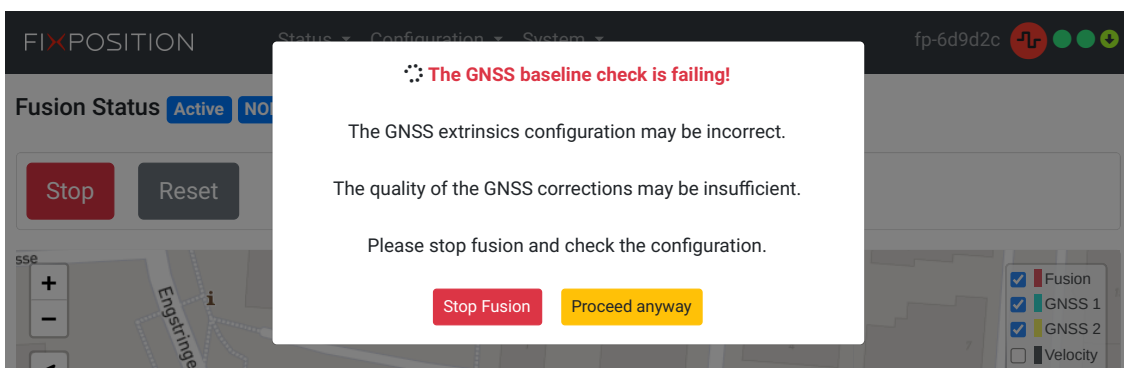

Figure 5.41.: GNSS baseline check error message on the web interface

In addition, this warning can be triggered when the basestation is too far away. We recommend the selected basestation to be less than 15 km from the rover. The sensor might experience degraded performance if the selected RTK basestation is slightly far away (> 15 km). The sensor will experience degraded performance and difficulties computing an RTK-fixed solution if the basestation is excessively far away (> 25 km). In this case, please choose a different NTRIP mountpoint or re-connect to the VRS service.

To determine the status of the Fusion engine and its related processes, the user can visualize the flags displayed on the Fusion Status page. Fig. 5.42 shows all possible badges that can be shown on this page.

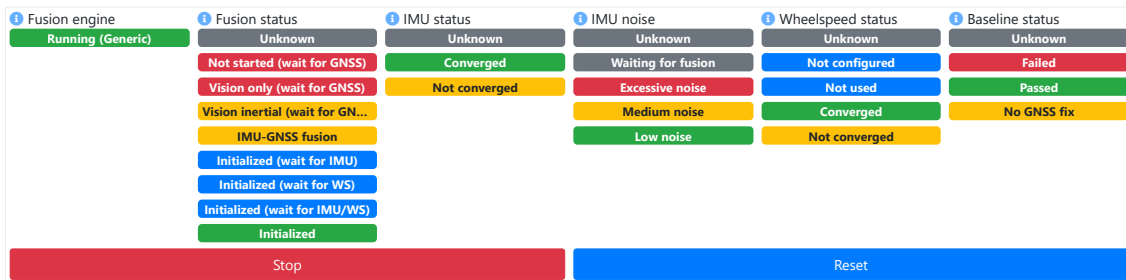

Figure 5.42.: Status badges available on the Fusion Status page of the web interface

Notes:

- There are four distinct badges for the Fusion initialized state. If the IMU and/or the wheelspeed sensors (only if configured) have not yet converged, one of the three blue "Initialized (wait for . . .)" badges is shown. Only once the IMU and/or WS have converged is the fourth green "Initialized" badge shown.
- The Baseline check status badge, available since 2.85.3, displays the average baseline check status over the last 5 seconds. When both GNSS receivers are in RTK fixed, the passed/failed is based on the difference between the configured and measured baseline. If one or both receivers are not in RTK fixed mode, the check result is "No GNSS fix". In summary:
 - a) If 80% or more checks are passed in that period, the badge shows "Passed."
 - b) If less than 80% of checks passed and at least one failed check, the badge shows "Failed".
 - c) If less than 80% of checks are passed and there are no failed checks, the badge shows "No GNSS fix".

5.14. Web interface tools

The Web interface presents several tools on its "System → Tools" page to reset stored data and configuration of the Vision-RTK 2, configure the Web Interface password, map access token, enable advanced options, and request remote support. Figure 5.43 presents all the available tools.

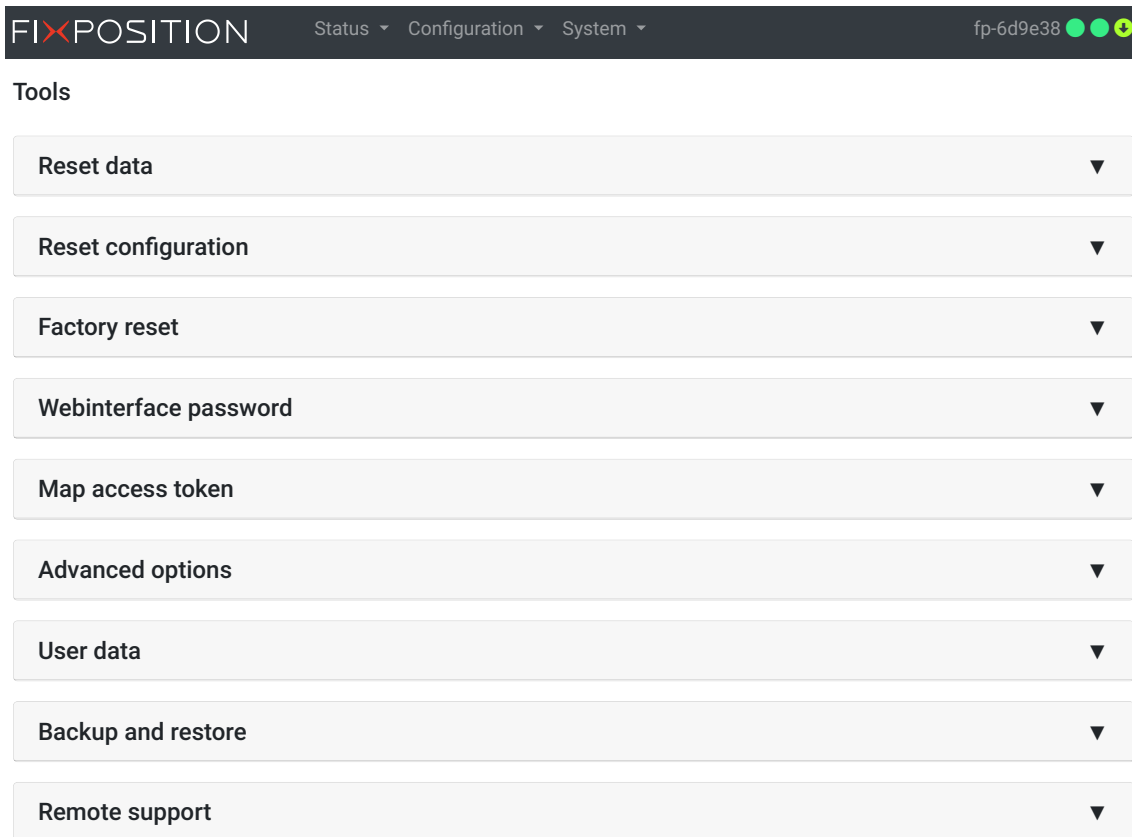

Figure 5.43.: Tools available on the web interface

The following tools are available on the Web interface:

- **Reset data:** This resets all persistent Fusion data, such as estimated IMU biases or wheelspeed scale factors.
- **Reset configuration:** This resets the following:
 - Configuration parameters (Fusion, camera, wheelspeed, I/O)
 - Wi-Fi interface configuration (mode, AP)
 - GNSS correction configuration
 - Fusion autostart
 - Fusion data
 - CAN interface configuration
 - PTP configuration
 - Web interface password
 - Advanced options
 - Map token

It does not reset the following:

- Network configuration (Wi-Fi client, Wi-Fi access point, ethernet)
- Recorded logs (internal disk)
- Recorded camera bags
- Camera calibration

■ **Factory reset:** This resets the following:

- Configuration parameters (Fusion, camera, wheelspeed, I/O)
- Network configuration (Wi-Fi client, Wi-Fi access point, ethernet)
- Wi-Fi interface configuration (mode, AP)
- GNSS correction configuration
- Fusion autostart
- Fusion data
- CAN interface configuration
- PTP configuration
- Web interface password
- Advanced options
- Map token
- Recorded logs (internal disk)
- Recorded camera bags

It does not reset the following:

- Camera calibration

■ **Web interface password:** Set up a username and password to protect unwanted access to the Web interface and corresponding sensor configuration.

■ **Map access token:** Provide a custom Mapbox access token or leave empty to use the built-in default token. In summary, this allows to change the map employed in the "Status → Fusion" page.

■ **Advanced options:** Enable the desired hidden features by providing the corresponding strings. Each advanced feature string must be separated by a semicolon. For further information, please ask the Fixposition team directly.

■ **User data:** Store a String or JSON with user data, helpful to identify a device or configuration mode, write notes, or add comments to the backup file. Note that the String input ignores special characters, and the JSON file must be valid.

■ **Backup and restore:** The configuration from the sensor can be backed up and saved as a JSON file. Backup data can be loaded from the file and applied to this or other sensors. Note that:

- Credentials, such as web interface protection or Wi-Fi passwords, cannot be retrieved from the sensor for privacy/security reasons. The passwords can be manually added to the backup data.

- A sanity check will be performed when restoring a configuration file. However, if restoring the configuration fails, no detailed information on what exactly has failed is provided. Make sure all fields are complete and valid.
 - The user can omit sections in the backup JSON file, and the respective configuration in the sensor is untouched. However, all sections included in the file must be complete and valid.
 - The interface will display a warning to the user before applying the configuration file if it comes from a different device, hardware version, or software version or does not include the corresponding passwords for NTRIP, web interface, or network connections.
- **Remote support:** By starting remote support, you allow Fixposition support to access your sensor remotely. For this to work, the sensor must have access to the Internet. When running (started), the sensor establishes a secure network connection to Fixposition's server. When not running (stopped), no connection is attempted, and no network traffic is happening. Note that this is only a support functionality and is disabled by default. In addition, this functionality is disabled after a reboot.

The Remote Support functionality provides secure remote access via the web (HTTP), shell (SSH), file transfer (SCP, SFTP), and other protocols to Fixposition's sensors. Any network-connected sensor running the Remote Support functionality can be securely accessed remotely over the Internet through our reflector server. This feature even works if the sensor is behind a NAT router, firewall, or proxy server. The sensor becomes just another host on the Internet, addressable via its URL and protected by Fixposition's reflector server against unauthorized or malicious access.

Status Dashboard

6.1. GNSS solution types

The following RTK/GNSS fix convention is used:

Fix type	Value	Color code	Description
Unknown	0	Dark	The receiver has no satellite signals.
No fix	1	Blue	The receiver has not enough satellite signals.
Reserved	2	-	-
Reserved	3	-	-
Single 2D	4	Red	Autonomous GNSS fix with very few available satellite signals.
Single 3D	5	Orange	Autonomous GNSS fix, typical in situation where no correction data is received or in outages.
Reserved	6	-	-
RTK float	7	Yellow	RTK with ambiguities not fully solved.
RTK fixed	8	Green	RTK with ambiguities fully solved.

Table 6.1.: List of RTK/GNSS signal qualities

6.2. GNSS status dashboard

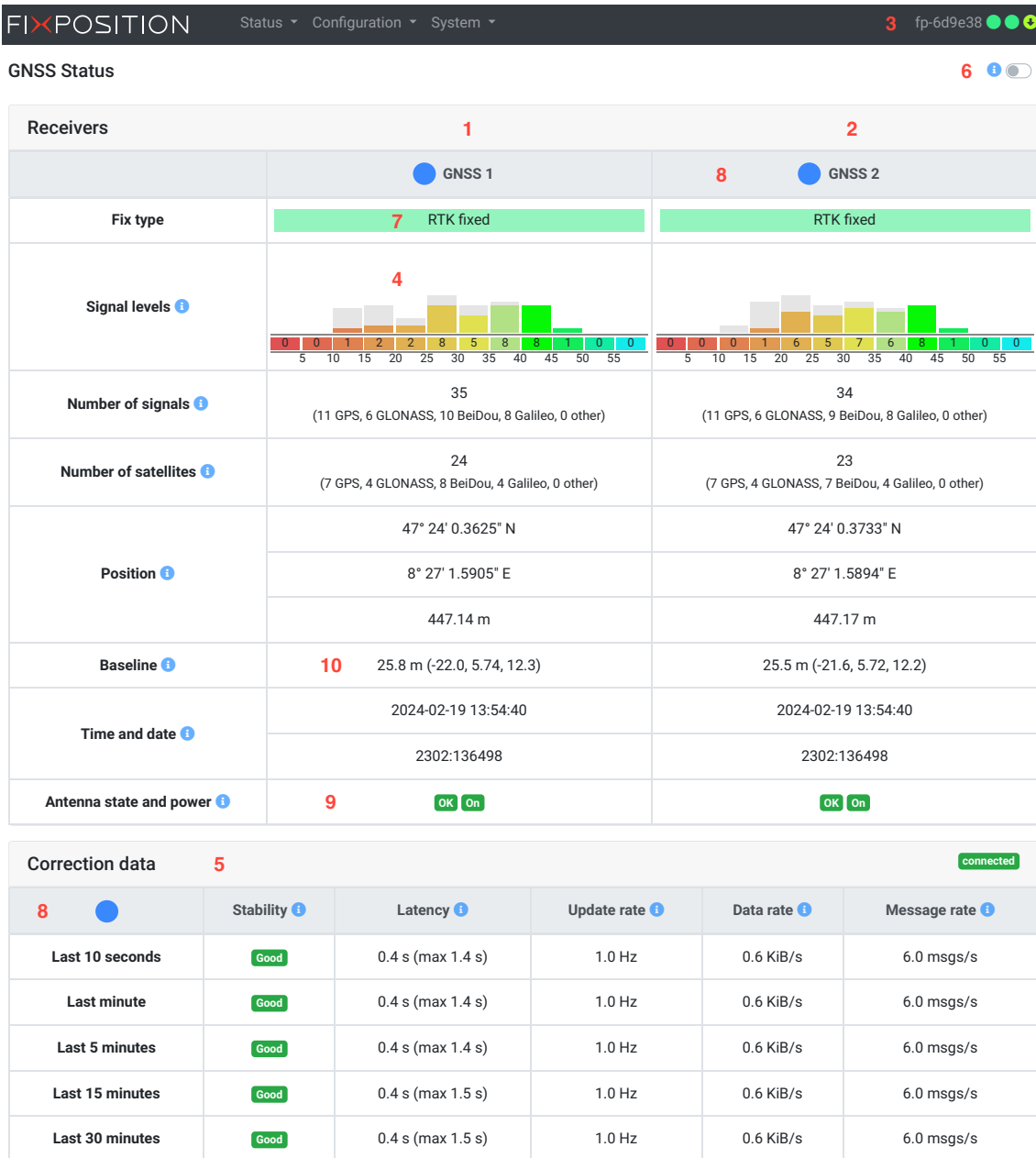

Figure 6.1.: GNSS status dashboard

- Left column:** status of first GNSS receiver.
- Right column:** status of second GNSS receiver.
- Status flags:** these 3 signal light indicate the status of the GNSS and NTRIP messages
 - GNSS 1: **Green** - Fixed, **Yellow** - Float, **Orange** - Single, **Gray** - No data.
 - GNSS 2: **Green** - Fixed, **Yellow** - Float, **Orange** - Single, **Gray** - No data.
 - NTRIP stability: **Green** - Good, **Yellow** - Warn, **Orange** - Poor, **Gray** - No data.
- Signal levels:** histogram of the number of GNSS signals and their corresponding signal levels (measured as the carrier to noise ratio in dB Hz). The coloured bars

represent the number of signals used in navigation and the gray ones represent the total number of signals tracked. The color scheme used for this histogram corresponds to:

- a) Reds: low signal levels, typically unusable or imprecise
- b) Greens: good signal levels (40+ dBHz)

5. **NTRIP correction stream stability and latency statistics:** display statistics of the NTRIP correction stream. Note: The user can only rely on these values when the system time is synchronized with either an NTP server or GNSS. These statistics are calculated using only GPS MSM messages (RTCM3 message type 1074, 1075, or 1077), available only in RTCM3.2 and above.

- a) Latency: measured by comparing the timestamp of the RTCM3 messages to the system time.
- b) Update rate: indicates how many sets of correction measurements are received per second. Different RTK services have different update rates. Typically it is 1 Hz nominal, but the sensor supports from 0.5 up to 2 Hz.
- c) Data rate: indicates how much data is received per second. Typically, between 0.5 to 1.5 KB/s.
- d) Stability indicators: **Green** - Good, **Yellow** - Warn, **Orange** - Poor, **Gray** - No data. These values are based on thresholds. For “good” stability, the update rate should be higher than 0.25Hz, the latency lower than 5s, and the maximum latency lower than 10s.
- e) The rows will only become available when the stream has run long enough. Changing the NTRIP configuration, internet outages, web interface disconnection, etc., can lead to artifacts.

6. **Expert mode toggle:** display additional information in the tables

7. **GNSS fix types:** they can be one of the following:

- a) **No fix** – the GNSS receiver has no fix at all.
- b) **Dead-reckoning** – The GNSS receiver has lost the fix and is extrapolating the movement.
- c) **Single 2D** – autonomous GNSS fix, 2D as only a few signals are available.
- d) **Single 3D** – autonomous GNSS fix. Typical situation if no RTK correction data is available.
- e) **RTK float** – real-time kinematic fix with ambiguities not fully solved.
- f) **RTK fixed** – real-time kinematic fix with ambiguities fully solved.

8. **Update indicators:** these indicators blink whenever the data is updated.

- a) For GNSS 1 and GNSS2, the indicator blinks at 1 Hz; more or less in sync.
- b) The NTRIP indicator blinks at 0.2 Hz (every 5 seconds).

9. **Antenna state and power:** displays antenna supervisor state (left badge) and the antenna power supply status (right badge).
 - a) Antenna states:
 - i. **Initialising** – During startup of the GNSS receiver.
 - ii. **OK** – Antenna detected and OK, power will be On.
 - iii. **Open** – No antenna detected, power will be On.
 - iv. **Short** – Antenna short circuit detected, power will be Off.
 - b) Power states:
 - i. **On** – Antenna power supply enabled.
 - ii. **Off** – Antenna power supply disabled. Note that after removing the electrical short it can take the GNSS receiver up to one minute to detect this and return to power On.
10. **Baseline:** Relative position (NED coordinates) from the basestation to the rover. As stated in Section 4.1, we recommend the selected basestation to be less than 15 km from the rover.

Note: The 'Time and date' fields display the current estimate using the solutions from each u-blox F9P GNSS receiver independently. The user should not trust these measurements when the values are in gray.

6.3. Input/output dashboard

I/O status								
Output	UART1	UART2	TCP0	TCP1	TCP2	TCP3	TCP4	CANSTR
Bytes	28'107'815	149	...9'823'373	...9'823'373	...9'823'373	...9'823'373	...9'823'373	149
Messages	92'915	3	6'995'924	6'995'924	6'995'924	6'995'924	6'995'924	3
Errors	0	0	0	0	0	0	0	0
FP_A-CORRIMU	0	0	1'552'332	1'552'332	1'552'332	1'552'332	1'552'332	0
FP_A-GNSSANT	0	0	7'021	7'021	7'021	7'021	7'021	0
FP_A-GNSSCORR	0	0	7'020	7'020	7'020	7'020	7'020	0
FP_A-LLH	0	0	77'421	77'421	77'421	77'421	77'421	0
FP_A-ODOMETRY	77'428	0	77'428	77'428	77'428	77'428	77'428	0
FP_A-RAWIMU	0	0	1'563'441	1'563'441	1'563'441	1'563'441	1'563'441	0
FP_A-TEXT_INFO	3	3	3	3	3	3	3	3
FP_A-TF_POIIMUH	0	0	1'563'119	1'563'119	1'563'119	1'563'119	1'563'119	0
FP_A-TF_POIVRTK	7'742	0	7'742	7'742	7'742	7'742	7'742	0
FP_A-TF_VRTKCAM	7'742	0	7'742	7'742	7'742	7'742	7'742	0
NMEA-GP-GGA_FUSION	0	0	77'421	77'421	77'421	77'421	77'421	0
NMEA-GP-GGA_GNSS	0	0	35'077	35'077	35'077	35'077	35'077	0
NMEA-GP-GGA_GNSS1	0	0	38'641	38'641	38'641	38'641	38'641	0
NMEA-GP-GGA_GNSS2	0	0	38'635	38'635	38'635	38'635	38'635	0
NMEA-GP-HDT_FUSION	0	0	77'424	77'424	77'424	77'424	77'424	0
NMEA-GP-RMC_GNSS	0	0	35'078	35'078	35'078	35'078	35'078	0
NMEA-GP-RMC_GNSS1	0	0	38'647	38'647	38'647	38'647	38'647	0
NMEA-GP-RMC_GNSS2	0	0	38'633	38'633	38'633	38'633	38'633	0
NOV_B-BESTGNSSPOS_GNSS1	0	0	38'644	38'644	38'644	38'644	38'644	0
NOV_B-BESTGNSSPOS_GNSS2	0	0	38'640	38'640	38'640	38'640	38'640	0
NOV_B-HEADING2	0	0	35'077	35'077	35'077	35'077	35'077	0
NOV_B-INSPVAX	0	0	77'409	77'409	77'409	77'409	77'409	0
NOV_B-RAWIMU	0	0	1'563'329	1'563'329	1'563'329	1'563'329	1'563'329	0
Input	UART1	UART2	TCP0	TCP1	TCP2	TCP3	TCP4	CANSTR
Bytes	0	0	0	0	0	0	0	0
Messages	0	0	0	0	0	0	0	0
Errors	0	0	0	0	0	0	0	0

Figure 6.2.: Input/Output Status dashboard

From software version 2.63 onwards, users can navigate to "System → Info" to supervise the I/O status. This panel shows statistics for all I/O ports (column). The available information for output (data sent by the sensor to the user) and input (data received by the sensor from the user) since boot is the following:

- **Bytes:** Accumulated data size in bytes sent and received from/to this port.
- **Messages:** Accumulated total number of messages sent and received from/to this port.
- **Errors:** Accumulated total number of errors sending and receiving data from/to this port.
- **For each recognized message, such as FP_A-ODOMETRY or FP_B-MEASUREMENT:** Accumulated total number of messages sent and received from/to this port.

The screenshot above shows that for port UART1, since boot, 28'107'815 bytes have been sent in 92'915 messages, and no errors in sending those have occurred. Of those messages, 77'428 were of type FP_A-ODOMETRY.

Software Updates

To update the software version of the Vision-RTK 2, head to the "System → Update" panel in the web interface and either click into the marked area and select the SWU file or drag and drop the corresponding SWU file inside the marked area (see Figure A.1).

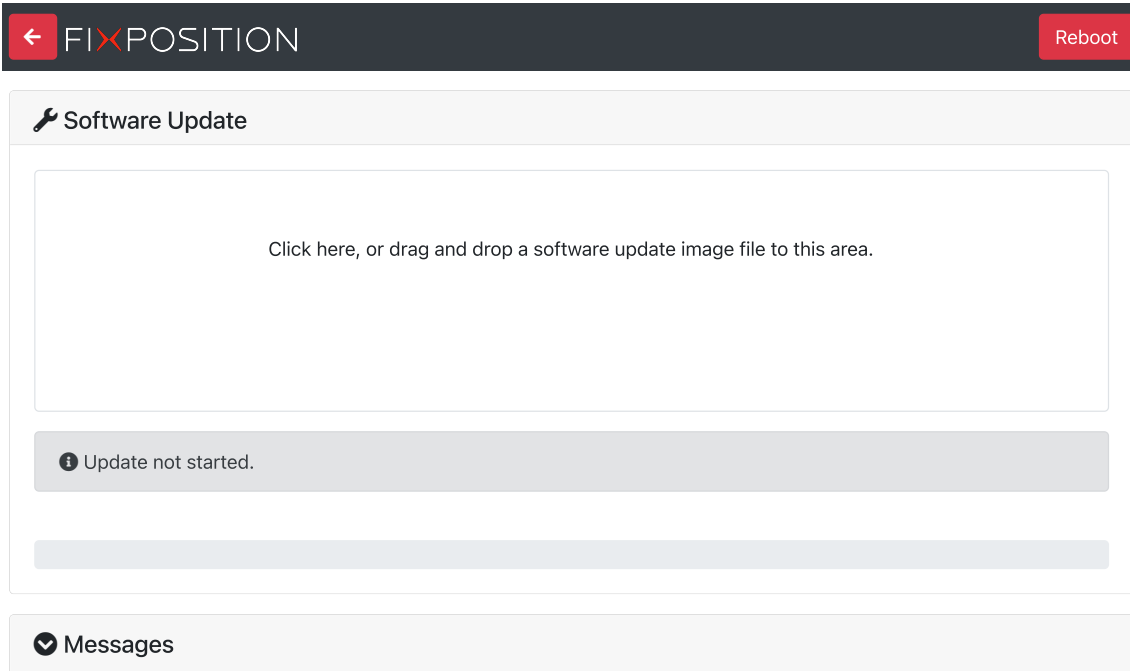

Figure A.1.: Software update in the web interface

Software updates are released every 6-10 weeks. Please email support@fixposition.com to be added to the distribution list.

We also provide Bash and Python scripts to upload the software image to the system and then wait for the notification of success or failure of the flash process. These tools can be found in the Fixposition Software Update library (https://github.com/fixposition/fixposition_utility/tree/main/software_update).

Note: When upgrading from 2.58.0 or earlier, the update page will get stuck at "The system will restart. Please be patient, as restarting takes about one minute". Please wait a minute and then manually open <http://10.0.1.1> to return to the main interface. This issue was caused by the software update page being moved from "<http://x.x.x.x:8080>" to "<http://x.x.x.x/update>". It is worth mentioning that even though the web interface no longer gets stuck after 2.58.0, it still takes quite a while until the sensor reboots.

Coordinate Transformations

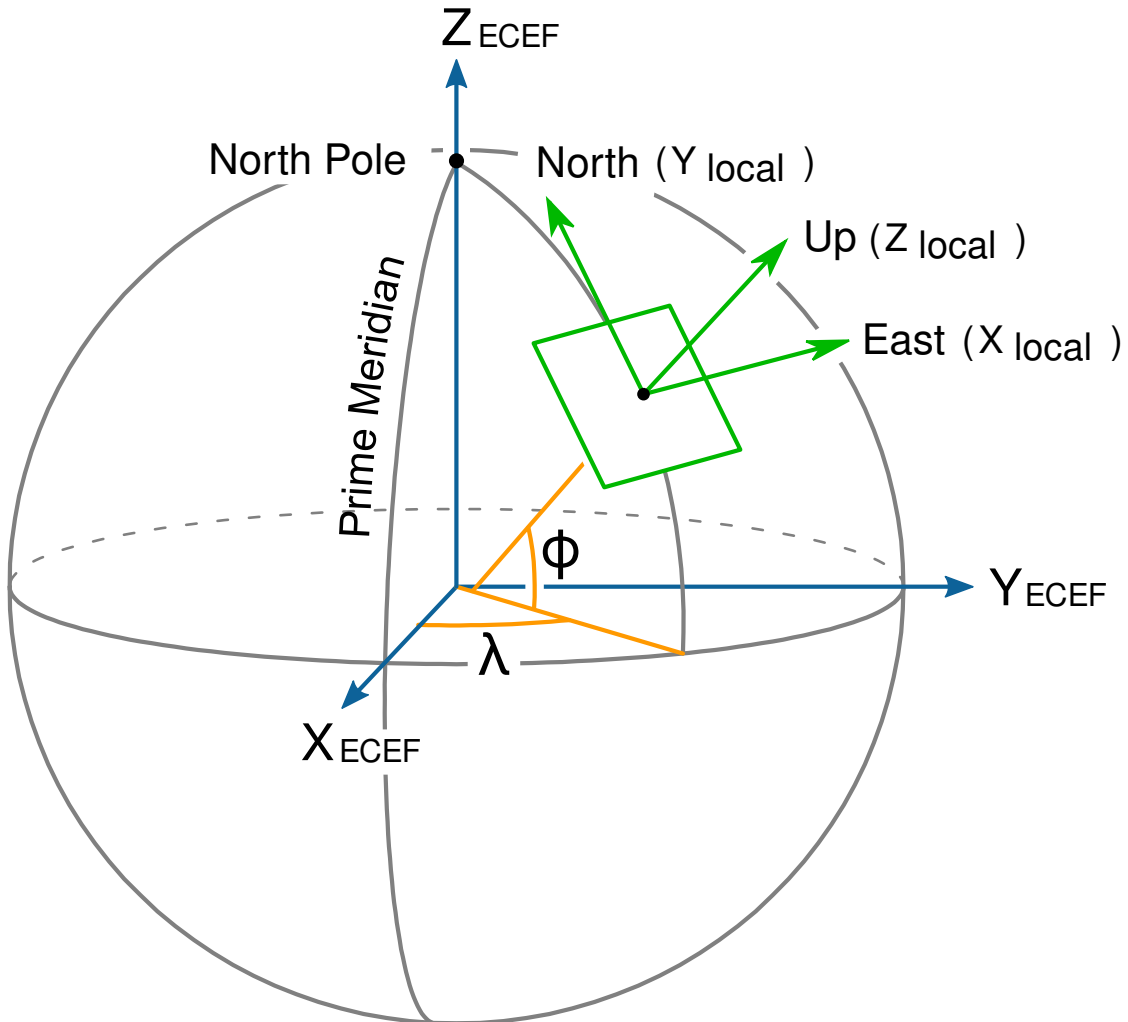

Figure B.1.: ECEF (global) and ENU (local) coordinate systems

Many different coordinate systems exist and are used to represent the pose of an object in space. Most of them can be classified into two groups: global systems, which approximate the entire Earth (e.g., WGS-84), and local systems, which use the best approximation of the local true geometrical shape of the Earth. ECEF coordinates (Earth-Centered, Earth-Fixed) are part of a global Cartesian system in which the center of the Earth is placed at the origin $\langle 0,0,0 \rangle$. The odometry output of the Vision-RTK 2 is given in ECEF coordinates.

Given that ECEF coordinates represent the pose of the sensor on a sphere, it is common to draw a tangential plane to represent the local pose of the robot. This representation is only accurate up to a certain distance from the origin (83 km on average) but makes tracking the odometry of the robot easier. For a local frame of reference, some outputs are given in ENU coordinates (East-North-Up). See Figure B.1 for a graphical explanation.

To convert the ECEF orientation of the Vision-RTK 2 into this local frame (ENU) coordinates, let's assume $\mathbf{q}_{\text{ecef} \rightarrow \text{body}}$ represents the orientation of the sensor in ECEF coordinates, which can be extracted from the pose output of the **FP_A-ODOMETRY** message. Then, the rotation from ECEF coordinates to the local frame of reference (ENU) can be computed using the current position of the sensor on the sphere $\langle \mathbf{x}, \mathbf{y}, \mathbf{z} \rangle$.

The Fixposition GNSS Transformation Lib(**fixposition_gnss_tf**) contains several useful functions for these space operations. For example, the function **TfEcefEcef()** takes an ECEF position coordinate and returns a rotation matrix that transforms from the ECEF plane to the ENU plane. Let's call this rotation matrix $\mathbf{R}_{\text{enu} \rightarrow \text{ecef}}$. As the orientation output of the Vision-RTK 2 sensor is represented using a quaternion, we need to first convert the rotation matrix to a quaternion $\mathbf{q}_{\text{enu} \rightarrow \text{ecef}}$. Thus, the rotation of the Vision-RTK 2 sensor in ENU coordinates can be computed as the multiplication of $\mathbf{q}_{\text{enu} \rightarrow \text{ecef}}$ times $\mathbf{q}_{\text{ecef} \rightarrow \text{body}}$. For a more in-depth explanation, please refer to the following:

- Transformations/ between/ ECEF/ and/ ENU/ coordinates
- Geographic/ coordinate/ conversion

Extract heading:

The **FP_A-ODOMETRY** message contains the position and orientation of the Vision-RTK 2 sensor in the ECEF coordinate system. For mathematical stability, the sensor employs quaternions to represent these rotations. Nonetheless, in case the user requires an Euler angles representation using Roll-Pitch-Yaw angles, it is necessary to first convert the orientation of the sensor into a local tangential coordinate system such as ENU or NED. To convert the reference frame from ECEF to ENU, we apply the following transformation:

$$\mathbf{R}_{\text{body} \rightarrow \text{enu}} = \mathbf{R}_{\text{ecef} \rightarrow \text{enu}} \cdot \mathbf{R}_{\text{body} \rightarrow \text{ecef}} \quad (\text{B.1})$$

where $\mathbf{R}_{\text{body} \rightarrow \text{ecef}}$ is the orientation of the sensor in the ECEF frame and $\mathbf{R}_{\text{ecef} \rightarrow \text{enu}}$ is the orientation of the ECEF frame in the ENU coordinate system (a local tangential plane). To convert $\mathbf{q}_{\text{body} \rightarrow \text{enu}}$ into Euler angles, it is possible to use either a rotation matrix or quaternions. For a rotation matrix, we apply the following equations:

$$\alpha = \tan^{-1} \left(\frac{R_{21}}{R_{11}} \right), \quad (\text{B.2})$$

$$\beta = \tan^{-1} \left(\frac{-R_{31}}{\sqrt{1 - R_{31}^2}} \right), \quad (\text{B.3})$$

$$\gamma = \tan^{-1} \left(\frac{R_{32}}{R_{33}} \right), \quad (\text{B.4})$$

where

$$\mathbf{R} = \begin{bmatrix} R_{11} & R_{12} & R_{13} \\ R_{21} & R_{22} & R_{23} \\ R_{31} & R_{32} & R_{33} \end{bmatrix} \quad (\text{B.5})$$

To convert a quaternion into yaw, pitch, and roll angles (ZYX order), the following equation can be used:

$$\alpha = \tan^{-1} \left(\frac{2q_x q_y + 2q_w q_z}{q_w q_w + q_x q_x - q_y q_y - q_z q_z} \right), \quad (\text{B.6})$$

$$\beta = \sin^{-1} (-2q_x q_z + 2q_w q_y), \quad (\text{B.7})$$

$$\gamma = \tan^{-1} \left(\frac{2q_y q_z + 2q_w q_x}{q_w q_w - q_x q_x - q_y q_y + q_z q_z} \right), \quad (\text{B.8})$$

where $\mathbf{q} = \langle q_w, q_x, q_y, q_z \rangle$. In this context, the Yaw angle with respect to the ENU (East-North-Up) frame represents the heading from East to North. To get the heading of the sensor from the North in a clockwise direction, we need to compute 90°-yaw. Alternatively, the user can calculate the rotation in NED (North-East-Down) coordinates and then extract the Roll-Pitch-Yaw angles with respect to NED, where yaw would be directly the heading in common sense. The function **EcefPoseToEnuEul()**, in the Fixposition GNSS Transformation Lib, receives the pose of the sensor in ECEF coordinates and returns the orientation of the robot in Yaw-Pitch-Roll angles using the equations described above.

Vision-RTK 2's output coordinate system:

The receiver output is always in the coordinate reference system (geodetic datum) used by the correction data service. In RTK mode, the receiver does relative positioning with respect to the base coordinates provided by the correction data service. The system in which those base coordinates are is entirely up to the correction data service provider. The receiver does not need or use this information at all. This is true for all ECEF (XYZ) output. For lat/long/height output, the WGS84 parameters are used to transform ECEF XYZ to lat/lon/height. In non-RTK mode, the output position is WGS84.

Camera FOV Data and Model

- Diagonal Field of View (DFOV) = 106.8°
- Horizontal Field of View (HFOV) = 100°
- Vertical Field of View (VFOV) = 64°

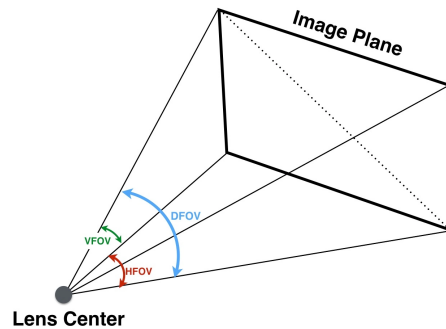

Figure C.1.: An illustration of the definition of D H V FOV

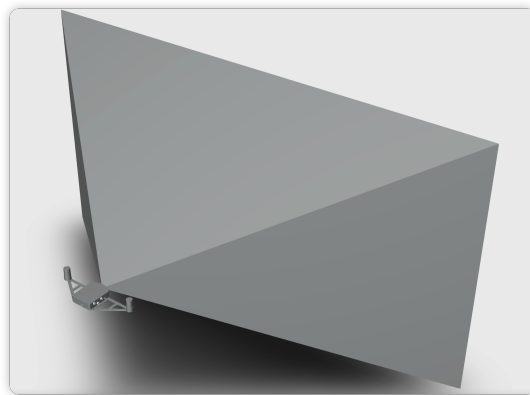

Figure C.2.: A schematic of the Vision-RTK 2's FOV

The STEP file of the Vision-RTK 2 FOV model is available at: <https://docs.fixposition.com/fd/step-model-and-camera-fov-data>.

* The DFOV (see figure below) is the angle subtended by the diagonal of the camera sensor onto the center of the lens.

Antenna Selection

The Vision-RTK 2's GNSS receivers require signals located at the L1 and L2 bands for adequate operation. Based on our internal testing, we recommend using helical antennas with a gain of around 35 dB. For reference, our evaluation kit ships with two Hi-Target AH-3232 antennas. The frequency response of the GNSS antennas should be approximately located at the [1195 - 1280] MHz and [1560 - 1610] MHz bands. On top of that, for helical antennas, we recommend a noise figure lower than 1.5 dB.

Other antenna types (e.g., patch, short helical) should be evaluated carefully depending on their placement with respect to other electrical components and the shape of the ground plane provided for them. Thus, besides using a suitable and good antenna (and appropriate cabling), the placement of the antenna is important. See below and for example the following u-blox document: https://content.u-blox.com/sites/default/files/ZED-F9P_IntegrationManual_UBX-18010802.pdf

Antenna assemblies that combine multiple antennas (such as, GNSS, Wi-Fi and cellular) in once casing are not recommended at all. While such antennas work fine for autonomous standard (C/A only) GNSS, they are likely to have bad performance for high-precision GNSS that require phase measurements, such as RTK. Also, the GNSS performance may depend on activity of the other antennas (Wi-Fi signal strength, cellular band used, etc.).

For further analysis, besides analyzing the position estimate performance of the sensor, one can look at the "Receiver RF AGC" value located at the advanced "GNSS status" tab in the web interface. The expected values should ideally be located between 20 and 80 percent. For additional information, see also the following U-Blox document: https://www.u-blox.com/sites/default/files/products/documents/GNSS-Antennas_AppNote_%28UBX-15030289%29.pdf.

Only active antennas (with a built-in LNA) are suitable for the Vision-RTK 2 sensor.

ROS topic output rate accuracy

The output rate of the ROS topics published by the Vision-RTK 2 is accurate. However, when looking at the recordings or plotting the received messages, the user might observe the following behavior:

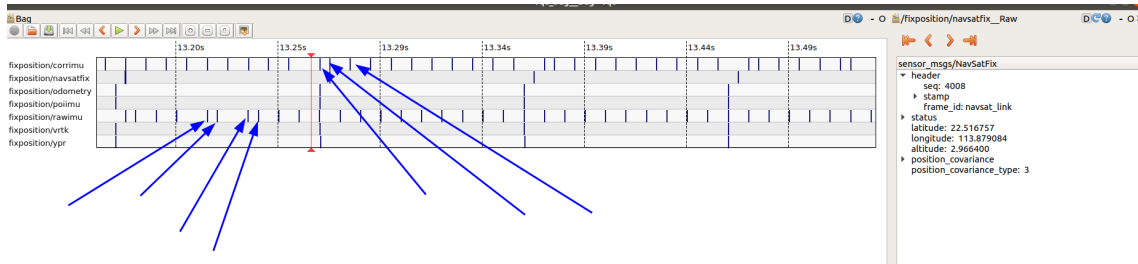

Figure E.1.: Delays in the time of arrival of ROS messages

As observed in Figure E.1, the rate of the output messages is not constant when looking at the time of arrival. However, this is the expected behavior of the sensor, as:

1. The Vision-RTK 2 is not a real-time system.
2. All the communications are not guaranteed to be real-time: Vision-RTK 2→TCP→User ROS→Bag recording. There are too many steps to then look at the time of arrival of the ROS messages.
3. The user should rely on the message's timestamp, not the time of arrival.